

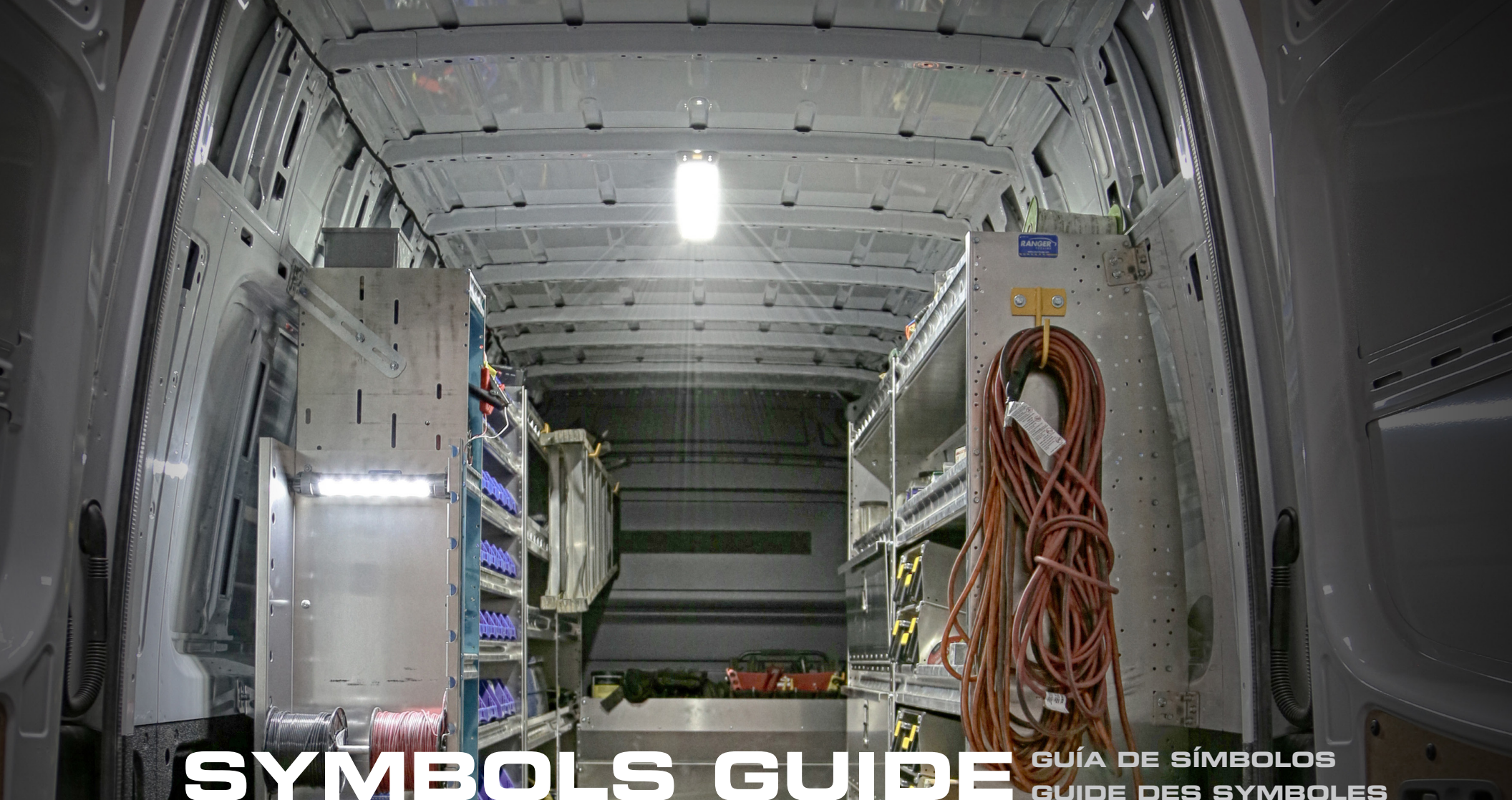

TRANSIT VAN SOLUTIONS

SOLUCIONES PARA CAMIONETAS TRANSIT
SOLUTIONS POUR LES CAMIONNETTES



SYMBOLS GUIDE

GUÍA DE SÍMBOLOS
GUIDE DES SYMBOLES

#

Part Number
número de parte
numéro de pièce

C

Color
color
couleur

T

Type
tipo
type

V

Volts
voltios
volts

dB(A)

Decibels
decibeles
décibels

A

Amps
amperes
amps

L

Lumens
lúmenes
lumens



Beam Pattern
patrón de haz
type de faisceau



Mounting
montaje
montage



Approvals
aprobaciones
homologations



Warranty
garantía
garantie



Switched
conmutado
commuté

GETTING THE JOB DONE SAFELY

In the past few years, the popularity of transit vans has risen tremendously in North America. The versatility of the vehicle has proven to be ideal for everyone from utility fleet owners to construction site workers. And because vans can serve so many different industries, the need for safety and warning equipment is monumental.

There are many benefits to a transit van – one of the most popular being its ability to be customized to the needs of almost any user. Shelving and racks can help tradesmen stay organized, while benches can help move a small construction crew and their materials in one trip.

No matter your needs, safety is always a priority. ECCO offers an extensive line of lighting and warning solutions that are ideally suited for all types of transit van applications. High-intensity LED warning light signals provides optimal rear and front visibility. Reversing safety solutions, which include industry-leading back-up alarms and camera systems, assist drivers with blind spots and help alert others of reversing vehicles.

[ESPAÑOL] REALIZACIÓN DEL TRABAJO EN FORMA SEGURA. En los últimos años, la popularidad de las camionetas Transit aumentó enormemente en Norteamérica. La versatilidad del vehículo ha demostrado que son ideales tanto para propietarios de flotas de vehículos utilitarios como para obreros de la construcción. Debido a que las camionetas resultan útiles en tantas industrias diferentes, es sumamente necesario equipamiento de seguridad y prevención. Las camionetas Transit presentan muchos beneficios y uno de los más populares es su capacidad de adaptación a las necesidades de prácticamente cualquier usuario. Los obreros pueden utilizar estantes y repisas que los ayuden a mantener el orden, y se pueden utilizar bancos para transportar una cuadrilla pequeña de obreros y sus materiales en un solo viaje. Independientemente de cuáles sean sus necesidades, la seguridad es siempre prioritaria. ECCO ofrece una amplia línea de soluciones de iluminación y prevención que son idealmente adecuadas para todo tipo de aplicaciones para camionetas Transit. Las señales luminosas de advertencia LED de alta intensidad brindan óptima visibilidad frontal y trasera. Las soluciones de seguridad en maniobras de reversa, las que incluyen alarmas de reversa y sistemas de cámara líderes en la industria, ayudan a los conductores a lidiar con sus puntos ciegos y a avisar a terceros que hay vehículos en maniobras de reversa. **[FRANÇAIS]** FAIRE LE TRAVAIL EN TOUTE SÉCURITÉ. Au cours de ces dernières années, la popularité des camionnettes a considérablement augmenté en Amérique du Nord. La polyvalence du véhicule s'est avérée être idéale pour tout le monde, depuis les propriétaires de flottes de services publics jusqu'aux travailleurs de chantiers. Et parce que les camionnettes peuvent servir autant de différentes industries, le besoin d'équipement de sécurité et d'avertissement est monumental. La camionnette comporte de nombreux avantages, l'un des plus populaires étant sa capacité de personnalisation selon les besoins de presque n'importe quel utilisateur. Les étagères et les supports peuvent aider les commerçants à s'organiser, tandis que les bancs peuvent permettre de transporter une petite équipe de construction et leurs matériaux en un seul voyage. Peu importe vos besoins, la sécurité est toujours une priorité. ECCO propose une gamme étendue de solutions d'éclairage et d'alarme qui conviennent parfaitement à tous les types de camionnettes. Les témoins lumineux à DEL haute intensité offrent une visibilité arrière et frontale optimale. Les solutions de sécurité pour recul, qui incluent des alarmes de recul et des systèmes de caméras de pointe, aident les conducteurs à éviter les risques associés aux angles morts et à alerter les autres conducteurs lorsqu'un véhicule fait marche arrière.

Take a look at our extensive line of products that will help you get your transit van job ready in no time.

Veá nuestra amplia línea de productos que le ayudarán a tener su camioneta Transit de trabajo lista en muy poco tiempo. Jetez un coup d'œil à notre vaste gamme de produits qui vous aideront à préparer rapidement votre camionnette.



LIGHTBARS

BARRAS DE LUCES | BARRES LUMINEUSES

Lightbar mounting kit options available at www.eccoesg.com
Kit de montaje de la barras de luces opciones disponible en www.eccoesg.com
Barres lumineuses montage options des kits disponibles à www.eccoesg.com

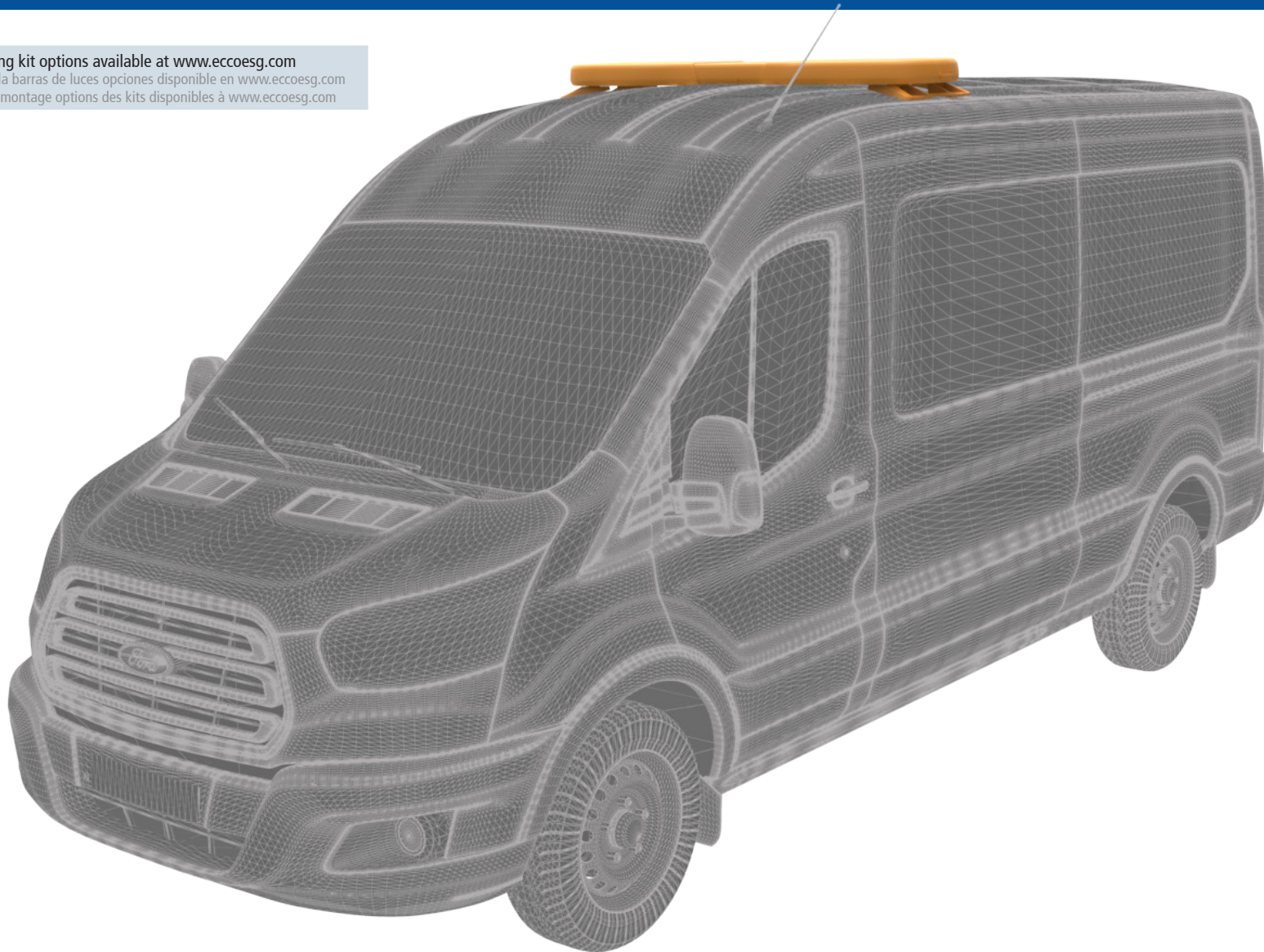

Recommended installation location | Ubicación de instalación recomendada | Emplacement d'installation recommandé

TRANSIT VAN SOLUTIONS

12 Series VANTAGE™

SAE Class I LED Lightbar



- 54"** # 12-20002-E (OPTIONAL - EZ0006)
- C** Amber
 - T** 16 LEDs
 - V** 12-24
 - A** 7.2
 - ☑ SAE J845 Class I, Cal. Title 13, CE, R10
 - 🕒 3 Year



- 60"** # 12-20003-E (OPTIONAL - EZ0006)
- C** Amber
 - T** 16 LEDs
 - V** 12-24
 - A** 7.2
 - ☑ SAE J845 Class I, Cal. Title 13, CE, R10
 - 🕒 3 Year

14 Series Axios®

SAE Class I Modular LED Lightbar



- 39"** # 14-00005-E
- C** Amber
 - T** 8 LEDs
 - V** 12-24
 - A** 7.2
 - ☑ SAE J845 Class I, Cal. Title 13, R65, R10
 - 🕒 5 Year



- 48"** # 14-00006-E
- C** Amber
 - T** 12 LEDs, 1 Safety Director
 - V** 12-24
 - A** 13.3
 - ☑ SAE J845 Class I, Cal. Title 13, R65, R10
 - 🕒 5 Year

21 Series

SAE Class I LED Lightbar



- 22"** # 21-00002-E
- C** Amber
 - T** 6 LEDs
 - V** 12
 - A** 3.0
 - ☑ SAE J845 Class I, Cal. Title 13
 - 🕒 5 Year

AVAILABLE COLORS (12, 14, & 21 SERIES)



- 47"** # 21-00004-E (OPTIONAL - EZ2127SB)
- C** Amber
 - T** 14 LEDs
 - V** 12
 - A** 7.0
 - ☑ SAE J845 Class I, Cal. Title 13
 - 🕒 5 Year



- 52"** # 21-00009-E (OPTIONAL - EZ2127SB)
- C** Amber
 - T** 16 LEDs, 6 Module Safety Director
 - V** 12
 - A** 8.0
 - ☑ SAE J845 Class I, Cal. Title 13
 - 🕒 5 Year

360° WARNING

ADVERTENCIA EN 360° | AVERTISSEMENT DE 360°

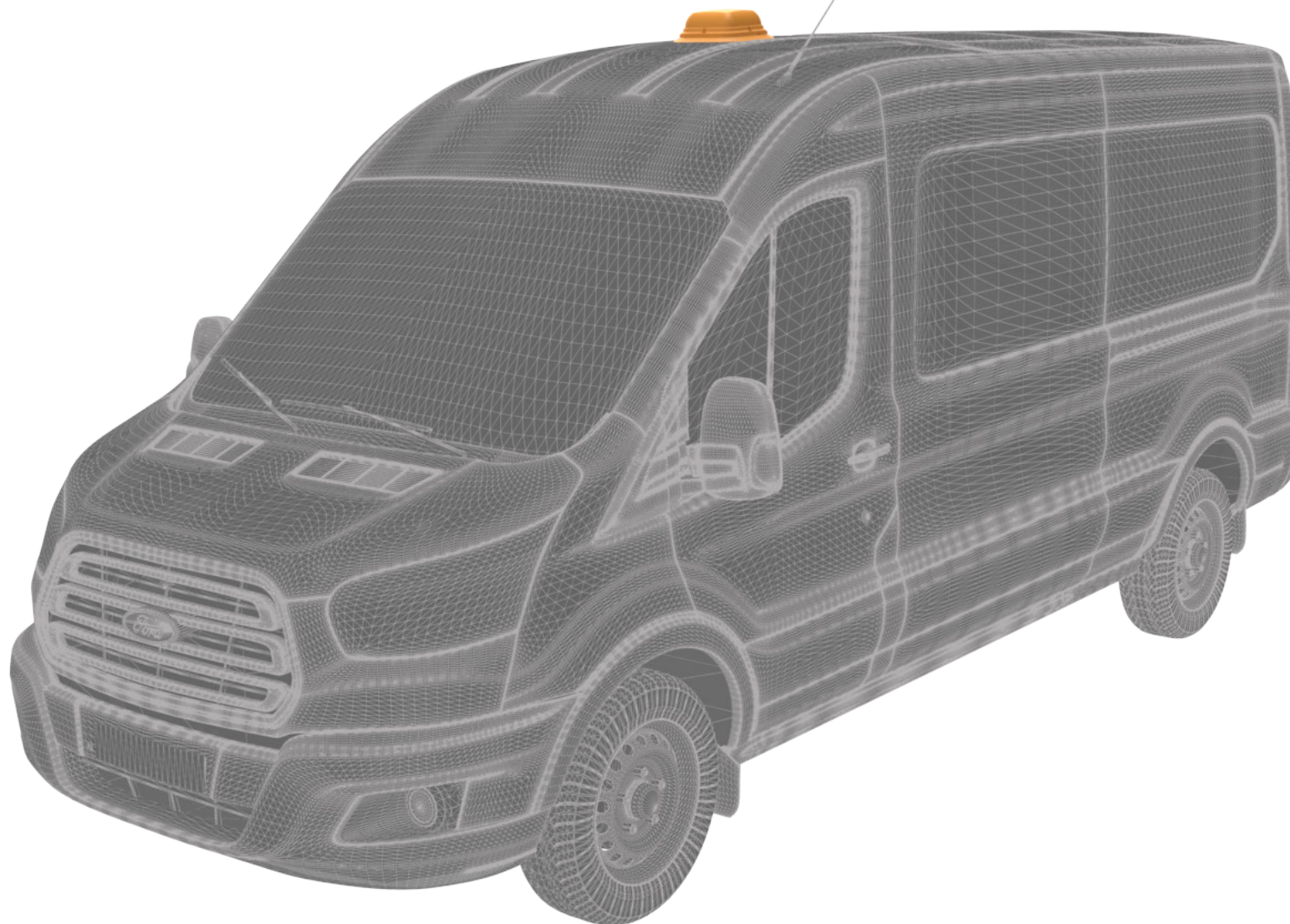

Recommended installation location | Ubicación de instalación recomendada | Emplacement d'installation recommandé

TRANSIT VAN SOLUTIONS

Minibars

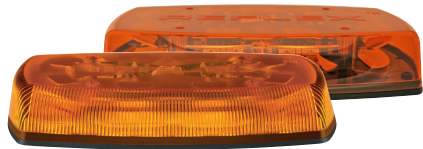

- # 5585A / 5587A Reflex®
- T 15"
- C Amber
- V 12-24
- A 5.1
- ✕ 4 Bolt
- ⊕ SAE J845 Class I, CE, R10, IP65, RoHS
- ⌚ 3 Year

AVAILABLE COLORS
(MG models amber illumination only)

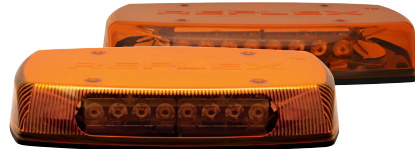

- # 5590A / 5597A Reflex®
- T 15"
- C Amber
- V 12-24
- A 6.0
- ✕ 4 Bolt
- ⊕ SAE J845 Class I, Cal. Title 13, CE, R10, IP65
- ⌚ 3 Year

AVAILABLE COLORS
(MG models amber & amber/clear only)

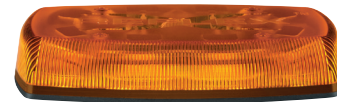

- # 5580A Reflex®
- T 15"
- C Amber
- V 12-24
- A 2.7
- ✕ 4 Bolt
- ⊕ SAE J845 Class II, CE, R10, IP65, RoHS
- ⌚ 3 Year

AVAILABLE COLORS



- # 5550A Reflex®
- T 11"
- C Amber
- V 12-24
- A 2.7
- ✕ 4 Bolt
- ⊕ SAE J845 Class I, Cal. Title 13, IP65, CE, R10, R65 (A,CA only), RoHS
- ⌚ 3 Year

AVAILABLE COLORS

Vacuum-Magnet Mounts Available
Disponibilidad de soportes con imán o vacío
Support à aimant sous vide

Semi-Permanent Mounting Base Available
Disponibilidad de con base de ensamblaje semipermanente disponible
Disponibilité de base de montage semi permanente

Beacons



- # EB7180A
- C Amber
- V 12-24
- A 6.2
- ✕ 4 Bolt
- ⊕ SAE J845 Class I, Cal. Title 13, R10, IP55, AMECA
- ⌚ 3 Year

AVAILABLE COLORS (EB7180)

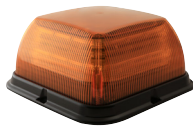

- # EB7185A Dual-color
- C Amber
- V 12-24
- A 8.6
- ✕ 4 Bolt
- ⊕ SAE J845 Class I, Cal. Title 13, R10, IP55, AMECA
- ⌚ 3 Year

AVAILABLE COLORS (EB7185)



- # 7945A / 7950A
- C Amber
- V 12-48
- A 1.3
- ✕ 3 Bolt / 1" Pipe
- ⊕ SAE J845 Class II, CE, R10, RoHS
- ⌚ 2 Year

AVAILABLE COLORS (7900 SERIES)



- # 7965A / 7970A
- C Amber
- V 12-24
- A 3.6
- ✕ 3 Bolt / 1" Pipe
- ⊕ SAE J845 Class I, CE, R10, RoHS
- ⌚ 2 Year

CA models = clear lens / amber illumination
Modelos CA = lente transparente / iluminación ámbar
Modèles CA = lentille claire/illumination ambrée

CC models = clear lens / clear illumination
Modelos CC = lente transparente / iluminación clara
Modèles CC = lentille claire/illumination claire

CAA models = clear lens / amber illumination
Modelos CAA = lente transparente / iluminación ámbar
Modèles CAA = lentille claire/illumination ambrée

CAC models = clear lens / amber and clear illumination
Modelos CAC = lente transparente / iluminación ámbar y clara
Modèles CAC = lentille claire/illumination ambrée et claire

CCC models = clear lens / clear illumination
Modelos CCC = lente transparente / iluminación clara
Modèles CCC = lentille claire/illumination claire

CAB models = clear lens / amber and blue illumination
Modelos CAB = lente transparente / iluminación ámbar y azul
Modèles CAB = lentille claire/illumination ambrée et bleu

CAG models = clear lens / amber and green illumination
Modelos CAG = lente transparente / iluminación ámbar y verde
Modèles CAG = lentille claire/illumination ambrée et vert

Where applicable, change A in part number to available color | En los casos aplicables, cambio de A en el número de parte para el color disponible. | Le cas échéant, remplacer le A dans un numéro de pièce par la couleur disponible

DIRECTIONAL WARNING

ADVERTENCIA DIRECCIONAL | ÉCLAIRAGE D'AVERTISSEMENT DIRECTIONNEL

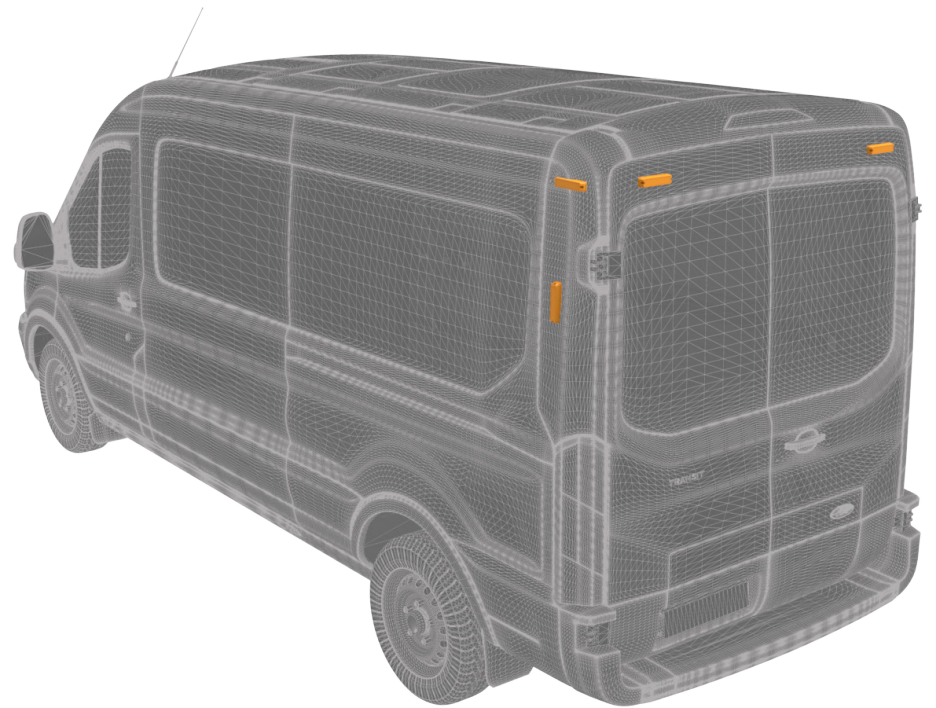
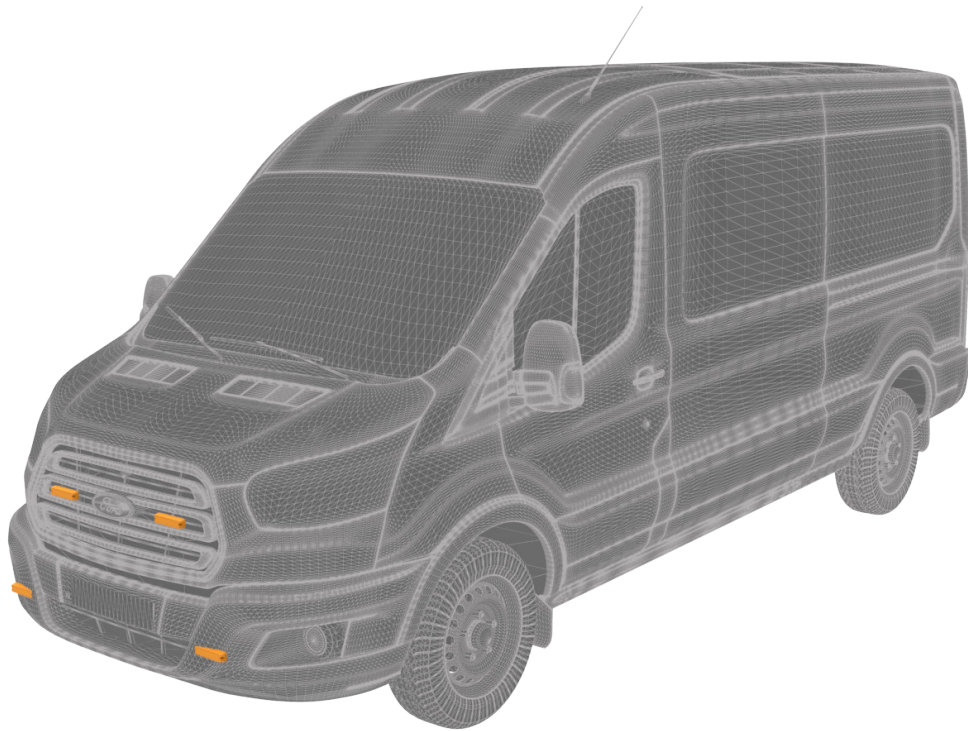

Recommended installation location options | Opciones de ubicación de instalación recomendada | Options d'emplacement d'installation recommandées

TRANSIT VAN SOLUTIONS



- # **ED3701A** Single- or Split-color
C Amber
V 12-24
A 0.8
X 2 Bolt
 SAE J595 Class I
 Cal. Title 13, R65, R10
 3 Year

AVAILABLE COLORS



- # **ED3706A** Single- or Split-color
C Amber
V 12-24
A 0.9
X Multi-Mount (surface, tilt bracket, self-adhesive, edge)
 SAE J595 Class I, Cal. Title 13, R65, R10, IP67
 3 Year

AVAILABLE COLORS



- # **3510A**
C Amber
V 12-24
A 0.75
X 2 Bolt
 SAE J595 Class I
 Cal. Title 13, CE, R10
 5 Year

AVAILABLE COLORS



- # **ED3702AC** Dual-color
C Amber/Clear
V 12-24
A 0.6
X 2 Bolt
 SAE J595 Class I
 Cal. Title 13, R65, R10
 3 Year

AVAILABLE COLORS



- # **ED3712AC**
C Amber/Clear
V 12-24
A 0.9
X Multi-Mount (surface, tilt bracket, self-adhesive, edge)
 SAE J595 Class I, Cal. Title 13, R65, R10
 3 Year

AVAILABLE COLORS



- # **ED3777A** Single- or Dual-Color
C Amber
V 12-24
A 1.8
X 2 Bolt
 SAE J595 Class I, R10
 3 Year

AVAILABLE COLORS



Synchronization Capable | Capacidad de sincronización | Capacité de synchronisation

Where applicable, change A in part number to available color | En los casos aplicables, cambio de A en el número de parte para el color disponible. | Le cas échéant, remplacer le A dans un numéro de pièce par la couleur disponible

WORKLAMPS

LUCES DE TRABAJO | LAMPES DE TRAVAIL

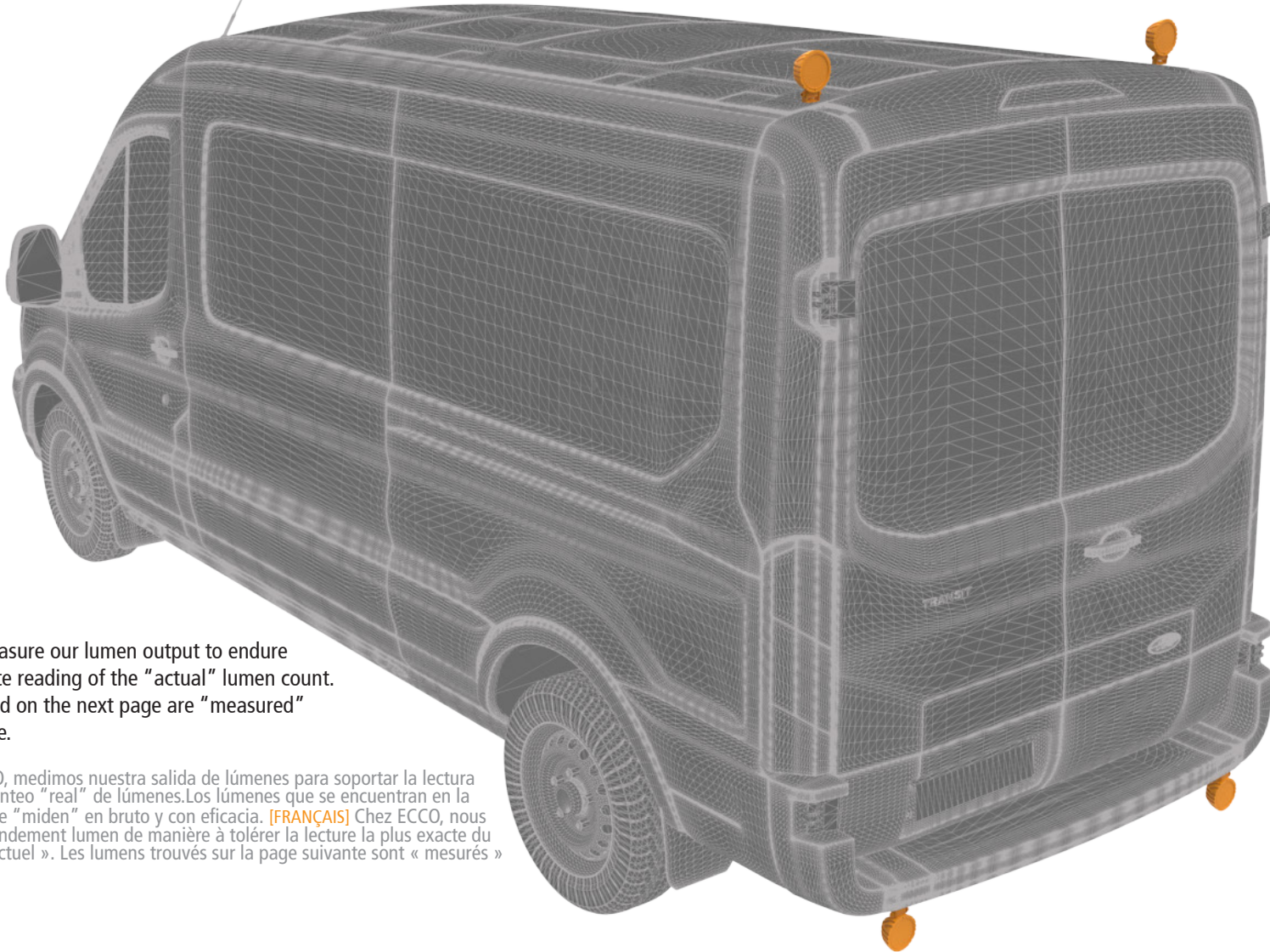



At ECCO, we measure our lumen output to endure the most accurate reading of the "actual" lumen count. The lumens found on the next page are "measured" raw and effective.

[ESPAÑOL] En ECCO, medimos nuestra salida de lúmenes para soportar la lectura más precisa del conteo "real" de lúmenes. Los lúmenes que se encuentran en la siguiente página se "miden" en bruto y con eficacia. [FRANÇAIS] Chez ECCO, nous mesurons notre rendement lumen de manière à tolérer la lecture la plus exacte du compte lumen « actuel ». Les lumens trouvés sur la page suivante sont « mesurés » bruts et actuels.

Recommended installation location options | Opciones de ubicación de instalación recomendada | Options d'emplacement d'installation recommandées



TRANSIT VAN SOLUTIONS



E92005
V 12-80
A 1.8
L 1000 Raw, 925 Effective
 Flood Inundación | Faisceau large
 CE, R10, IP67, UL, RoHS
 3 Year





EW211-DEU
 Available integrated Deutsch connector
 Conector Deutsch integrado disponible
 Disponible avec connecteur Deutsch intégré



EW2110
V 12-80
A 1.2
L 800 Raw, 750 Effective
 Flood Inundación | Faisceau large
 CE, R10, IP67, UL, RoHS
 3 Year





EW212-DEU
 Available integrated Deutsch connector
 Conector Deutsch integrado disponible
 Disponible avec connecteur Deutsch intégré

EW2112
V 12-80
A 1.6
L 1000 Raw, 950 Effective
 Flood Inundación | Faisceau large
 CE, R10, IP67, UL, RoHS
 3 Year





EW2409
V 12-24
A 1.3
L 850 Raw, 825 Effective
 Flood Inundación | Faisceau large
 CE, R10, IP67
 3 Year





EW2471
V 12-24
A 1.2
L 775 Raw, 725 Effective
 Flood Inundación | Faisceau large
 CE, R10, IP67
 3 Year





EW2481
V 12-24
A 1.2
L 800 Raw, 750 Effective
 Flood Inundación | Faisceau large
 CE, R10, IP67
 3 Year







EW2491
V 12-24
A 1.2
L 725 Raw, 700 Effective
 Flood Inundación | Faisceau large
 CE, R10, IP67
 3 Year





EW2102 Equinox™
V 12-24
A 2.6
L 2000 Raw, 1600 Effective
 Flood Inundación | Faisceau large
 CE, R10, IP67
 3 Year





EW2461CA-NA
C  / 
V 12-24
L 650 Raw, 600 Effective (clear)
 Flood Inundación | Faisceau large
 CE
 1 Year



E92006
V 12-24
A 1.3
L 1450 Raw, 1350 Effective
 Flood Inundación | Faisceau large
 CE
 2 Year



EW2105
V 12-24
A 1.2
L 800 Raw, 750 Effective
 Flood Inundación | Faisceau large
 CE, R10, IP67
 3 Year

INTERIOR LIGHTING

ILUMINACIÓN INTERIOR | ÉCLAIRAGE D'INTÉRIEUR

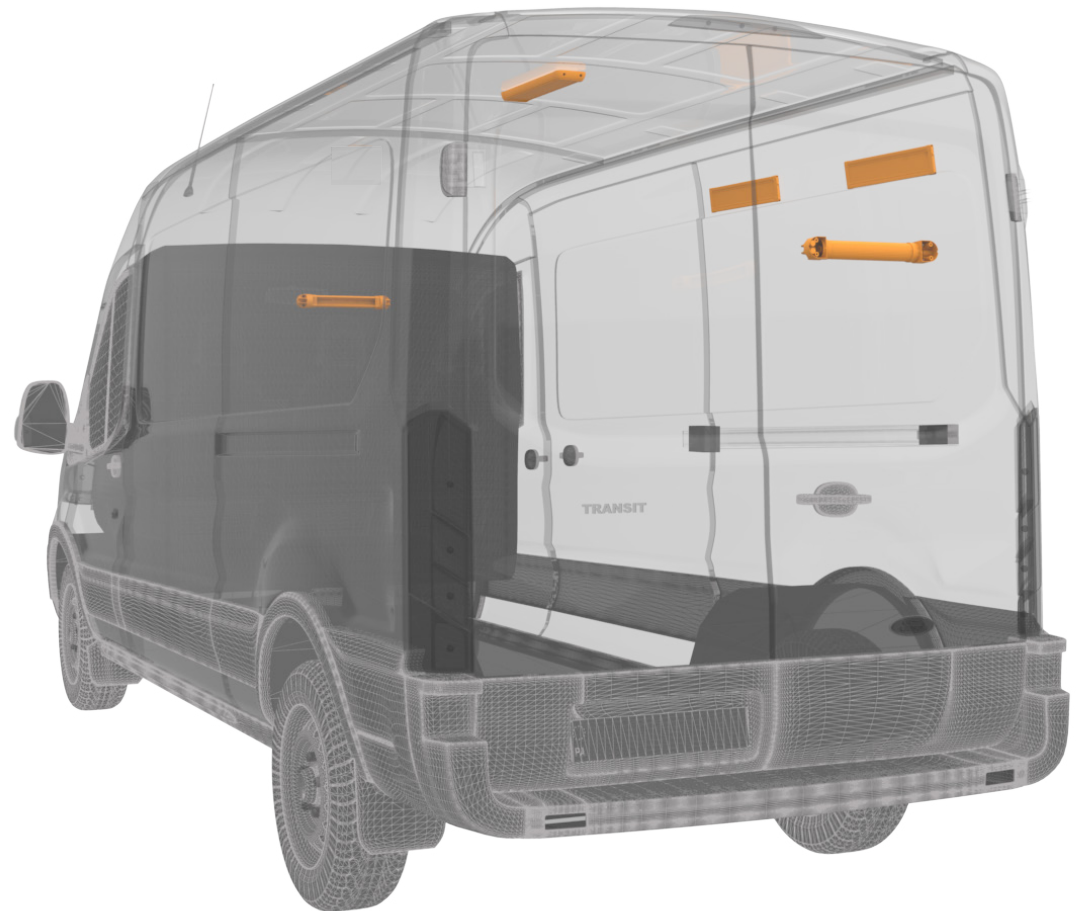

Recommended installation location options | Opciones de ubicación de instalación recomendada | Options d'emplacement d'installation recommandées

TRANSIT VAN SOLUTIONS

Strip Lighting



- 12"**
- # EW0116
 - T 18 LED
 - V 12
 - A 0.4
 - L 375
 - Flood Inundación | Faisceau large
 - CE, RoHS, IP65
 - 3 Year



- 50"**
- # EW0132
 - T 2 LED, 75 Modules
 - V 12
 - A 0.08
 - L 100
 - Flood Inundación | Faisceau large
 - CE, IP67, RoHS
 - 3 Year



- 20.6"**
- # EW0141
 - T 30 LED
 - V 12
 - A 0.8
 - L 750
 - Flood Inundación | Faisceau large
 - 3 Year

ACCESSORIES

EZO120 PIR Motion Sensor
 Sensor de movimiento PIR
 Capteur de mouvements PIR



EZO121 On/Off Switch
 Interruptor de encendido/apagado
 Commutateur marche / arrêt



EZO122 On/Off & Dimming Switch
 Interruptor de encendido/apagado y de atenuación
 Commutateur marche / arrêt et de gradation



Interior Lighting



- 5.4"**
- # EW0360
 - T 27 LED
 - V 12-24
 - A 0.5
 - L 400
 - Flood Inundación | Faisceau large
 - R10, IP67, RoHS
 - 3 Year



- 4.5" FROST**
- # EW0311
 - T 15 LED
 - V 12
 - A 0.1
 - L 100
 - Flood Inundación | Faisceau large
 - CE, RoHS
 - 3 Year



- 21.5"**
- # EW0801
 - T 24 LED
 - V 12-24
 - A 0.4
 - L 975
 - Flood Inundación | Faisceau large
 - R10, IP67, RoHS
 - 3 Year



- 7"**
- # EW0500
 - T 42 LED
 - V 12-24
 - A 0.5
 - L 250
 - Flood Inundación | Faisceau large
 - CE, R10, RoHS
 - 3 Year



- 15"**
- # EW0503
 - T 108 LED
 - V 12-24
 - A 0.8
 - L 600
 - Flood Inundación | Faisceau large
 - CE, R10, RoHS
 - 3 Year

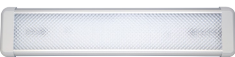

- 18"**
- # EW0600
 - T 96 LED
 - V 12-24
 - A 1.7
 - L 2000
 - Flood Inundación | Faisceau large
 - CE, RoHS
 - 3 Year



- 33"**
- # EW0602
 - T 192 LED
 - V 12-24
 - A 3.6
 - L 4900
 - Flood Inundación | Faisceau large
 - CE, RoHS
 - 3 Year



- 13"**
- # EW0700
 - T 6 LED
 - V 12-24
 - A 0.5
 - L 400
 - Flood Inundación | Faisceau large
 - CE, RoHS
 - 3 Year



- 22"**
- # EW0701
 - T 12 LED
 - V 12-24
 - A 0.9
 - L 1250
 - Flood Inundación | Faisceau large
 - CE, RoHS
 - 3 Year

REVERSING SAFETY

SEGURIDAD EN MARCHA ATRÁS | SÉCURITÉ DE REcul

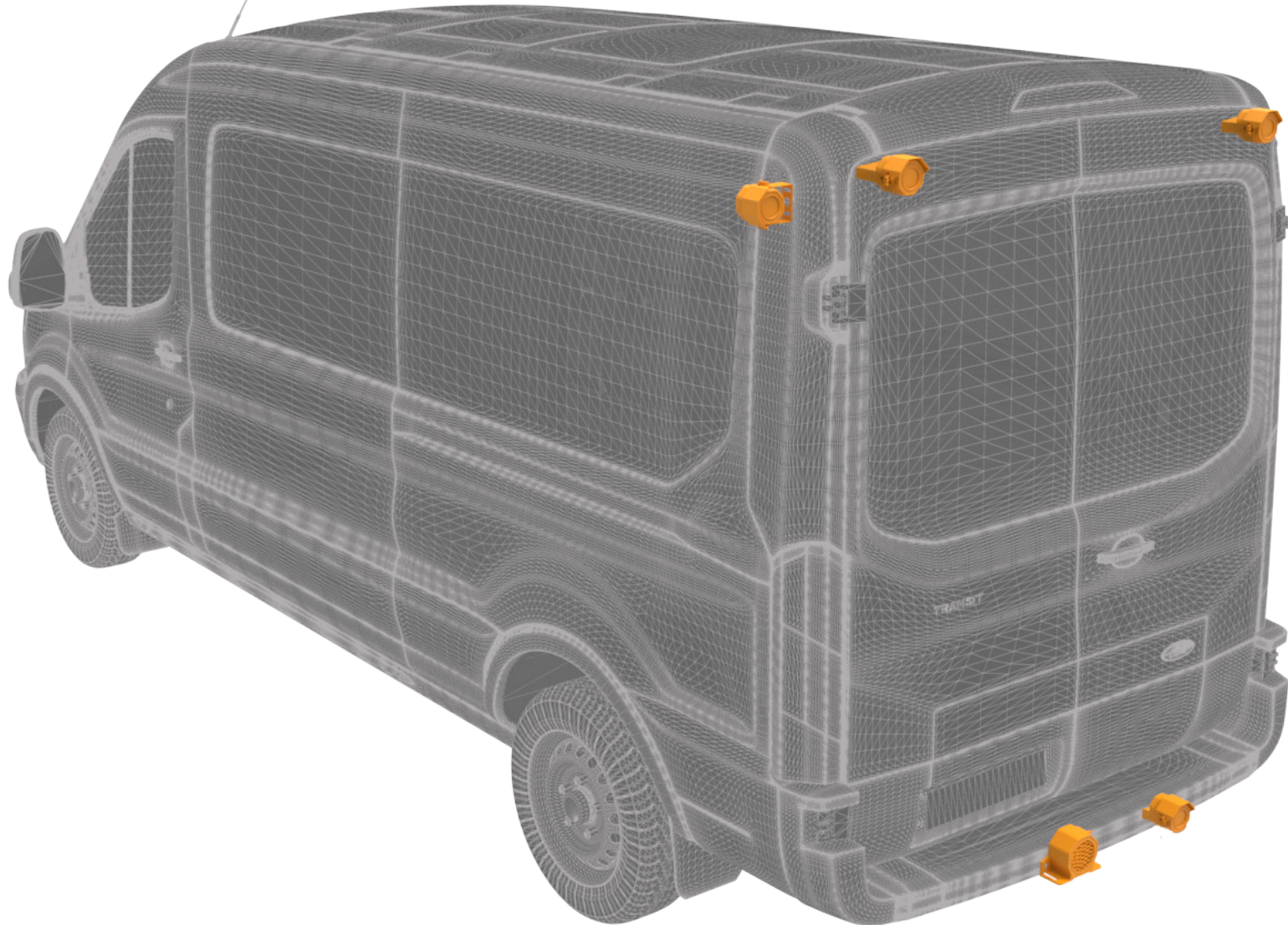

Recommended installation location options | Opciones de ubicación de instalación recomendada | Options d'emplacement d'installation recommandées

TRANSIT VAN SOLUTIONS

Back-Up Alarms



- # 520
- T SRC*
- V 12-24
- dB(A) 97
- A 0.2
- X 2 Bolt
- ⊗ SAE J994 Type C
CE, R10, UL, AMECA, IP65
- ⌚ 2 Year

- # 575
- T -
- V 12-24
- dB(A) 107
- A 0.9
- X 2 Bolt
- ⊗ SAE J994 Type B
CE, R10, UL
- ⌚ 2 Year

Multi-Frequency Alarm



- # EA5200
- T MFA
- V 12-24
- dB(A) 97
- A 1.0
- X 2 Bolt
- ⊗ SAE J994 Type C
CE, R10, AMECA
- ⌚ 2 Year



- # EA9724
- T Smart, MFA
- V 12-24
- dB(A) 77-97
- A 0.7
- X 2 Bolt
- ⊗ SAE J994 Type F,
CE, R10
- ⌚ ECCOLIFET™

Camera Systems



- EC7008-WK**
7" LCD color system
Quad view, split screen
SD card enabled & Auto Pair
4 camera expandable
Vista cuádruple, pantalla dividida
Pantalla de división cuádruple y habilitación de tarjeta SD
4 cámara expansible
4 affichages mosaïques, écran divisé
Écran quatre divisions accepte carte SD
4 cámaras extensible



- EC5605-WK**
5.6" LCD color system
2.4 GHz digital wireless system
CMOS 11 LED infrared camera
4 camera expandable
Sistema inalámbrico digital de 2,4 GHz
Cámara infrarroja 11 LED CMOS
4 cámara expansible
Système sans fil numérique de 2,4 GHz
Caméra infrarouge CMOS à 11 DEL
4 cámaras extensible



- EC5603-K**
5.6" LCD color system
Touchscreen menu control
CMOS 11 LED infrared camera
3 camera expandable
Control de menú en pantalla táctil
Cámara infrarroja 11 LED CMOS
3 cámara expansible
Contrôle du menu sur écran tactile
Caméra infrarouge CMOS à 11 DEL
3 cámaras extensible



- EC4200-K**
4.3" LCD Color Mirror System
Mirror integrated monitor
CMOS 10 LED infrared camera
Two camera expandable
Espejo monitor integrado
Cámara infrarroja 10 LED CMOS
2 cámara expansible
miroir moniteur intégré
Caméra infrarouge CMOS à 10 DEL
2 cámaras extensible



- EC4210B-K**
4.3" LCD color mirror system
Mirror integrated monitor
License plate bracket
Two camera expandable
Monitor integrado con espejo
Abrazadera para la placa de licencia
3 cámara expansible
Écran avec miroir intégré
Support de plaque d'immatriculation
2 cámaras extensible



Distributed by:

833 West Diamond Street, Boise, Idaho 83705
(800) 635-5900 | sales@eccolink.com | www.eccoesg.com
An **ECCO SAFETY GROUP™** Company



7 58379 07365 0

© 2017 Electronic Controls Company
TRANSITVANBROCHURE (817 - 5K)