

**TOMMY GATE®**



**2016**

# **LIFTGATE GUIDE**

**PRODUCTS • OPTIONS • APPLICATIONS**





---

## CONTENTS

### **10 PICKUP LIFTGATES**

- 10 G2 Series
- 12 Original Series

### **18 SERVICE BODY LIFTGATES**

- 18 G2 Series
- 20 Original Series

### **26 FLATBED, STAKE, & VAN BODY LIFTGATES**

- 26 Tuckunder Series — TKT Models
- 30 Railgate Series — High-Cycle, Bi-Fold Models
- 32 Railgate Series — High-Cycle, Fixed-Platform Models
- 36 Railgate Series — Standard, Dock-Friendly Models
- 38 Railgate Series — Standard, Fixed-Platform Models
- 42 G2 Series
- 44 Original Series

### **46 DUMP BODY LIFTGATES**

- 46 G2 Series — Lift-N-Dump

### **52 CARGO VAN LIFTGATES**

- 52 Cantilever Series
- 54 650 Series

### **55 APPLICATIONS & BRACKETS**

A large, white, three-dimensional sign is mounted on a brick wall. The sign features the text 'The original TOMMY GATE hydraulic lift' in blue and red. A red arrow icon points upwards from the word 'original'. The sign is set against a cloudy sky.

The original  
**TOMMY GATE**  
hydraulic lift

50  
1965 - 2015  
YEARS

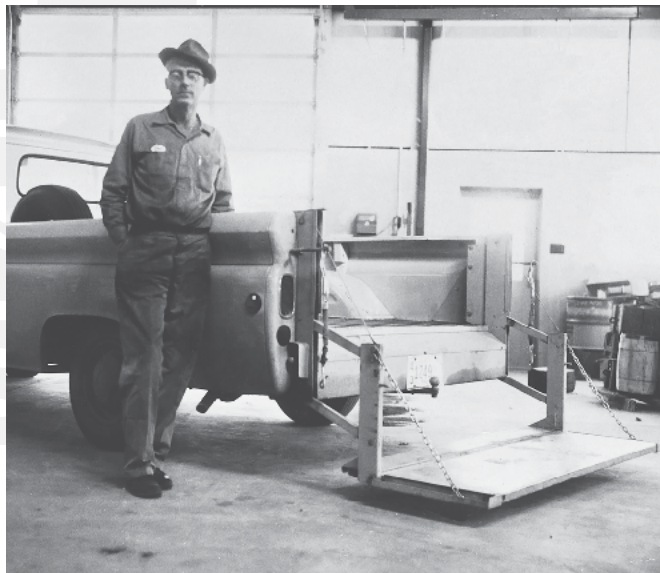

## THE ORIGINAL HYDRAULIC LIFT

Woodbine Manufacturing Company is the developer of Tommy Gate, a premier brand of private, commercial, and industrial hydraulic lifts. Established in Woodbine, Iowa in 1965 by Delbert “Bus” Brown, Tommy Gate has experienced steady growth in each of the past five decades and is widely celebrated as the industry leader.

Now sold in every corner of the world, Tommy Gate’s strong reputation for quality has been built through a strict adherence to the highest standards of engineering, craftsmanship, and customer service.



## PICKUP



## SERVICE BODY

### G2 SERIES

1500 LBS. CAPACITY

A dual-cylinder, parallel-arm design liftgate. Versatile, popular, and modern. [PAGE 10](#)

### G2 SERIES

1600 LBS. CAPACITY

A dual-cylinder, parallel-arm design liftgate. Versatile, popular, and modern. [PAGE 18](#)

### ORIGINAL SERIES

1000 LBS. CAPACITY

A single-cylinder liftgate based on a cable and pulley system. The classic Tommy Lift. [PAGE 12](#)

### ORIGINAL SERIES

1000 LBS. CAPACITY

A single-cylinder liftgate based on a cable and pulley system. The classic Tommy Lift. [PAGE 20](#)

# LIFTGATE OVERVIEW

Tommy Gate offers a full line of liftgates for any personal, commercial, or industrial application. Depending on your particular cargo-handling needs and your vehicle, certain liftgates may be more suitable than others. This guide is intended to help you most easily identify which Tommy Gate hydraulic lift is right for you.

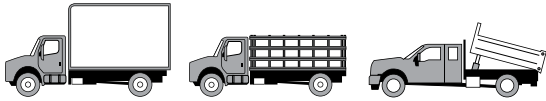

## FLATBED, STAKE, & VAN

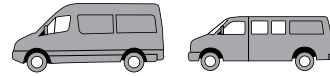

## CARGO VANS

### G2 SERIES

1600 LBS. CAPACITY

A dual-cylinder, parallel-arm design liftgate. Versatile, popular, and modern. PAGE 42

### CANTILEVER SERIES

1300 LBS. CAPACITY

A modern lift that is specifically designed to operate seamlessly with commercial vans. PAGE 52

### ORIGINAL SERIES

1600 LBS. CAPACITY

A single-cylinder liftgate based on a cable and pulley system. The classic Tommy Lift. PAGE 44

### 650 SERIES

650 LBS. CAPACITY

Low-capacity, compact, and internally-mounted; an ideal liftgate for lightweight vans. PAGE 54

### TUCKUNDER SERIES

3000 LBS. CAPACITY

Wide-arm, self-leveling, dual-cylinder liftgates that store underneath the vehicle bed. PAGE 26

### RAILGATE SERIES

#### HIGH-CYCLE MODELS

3000 LBS. CAPACITY

A level-ride liftgate ideal for handling heavy, sensitive, wheel-based cargo. PAGE 30

#### STANDARD MODELS

2000 LBS. CAPACITY

A level-ride liftgate ideal for handling heavy, sensitive, wheel-based cargo. PAGE 36

TOMMY GATE









**THE NEXT GENERATION**

The Tommy Gate G2 Series is a dual-cylinder, parallel-arm design which utilizes a pair of hydraulic cylinders to lower and raise the lift by applying direct power to both sides of the platform. G2 Series liftgates for pickups are versatile, popular, and modern.

◀ **G2-60-1542 EA38**

*Shown with optional rubber platform bumpers and discontinued recessed light kit. Recessed lights have been replaced by a bolt-on kit.*

Frames and platforms on every G2 Series liftgate are hand assembled and hand welded, while precision parts are laser cut and/or robotically welded.



**DUAL DRIVE ADVANTAGES**

Dual-drive liftgates provide increased durability for rigorous cycling and have low maintenance requirements. A paint-before-assembly process also increases the longevity of the lift's aesthetics.

**G2 SERIES LIFTGATE FEATURES**

- Dual hydraulic cylinders
- Virtually maintenance-free components
- Recessed control
- Larger platforms
- Fully-enclosed hydraulic system located within the lift mainframe



**SPECS**

**PICKUP — G2 SERIES**

**AVAILABLE MODELS**

TWO-YEAR STANDARD WARRANTY

	Model Number	Load Area	Taper	Travel	Platform Fold	Application <sup>1</sup>	Gate Weight
<b>1300 lb. Capacity</b>	<u>Treadplate Platforms</u>						
	<b>G2-60-1342 TP27</b>	55 x 27	4	42	No	A,B	438
	<b>G2-60-1342 TP38</b>	55 x 38	4	42	Yes	A,B	478
	<b>G2-60-1342 TP42</b>	55 x 42	7	42	Yes	A,B	503
	<u>TommyTraction™ Platform</u>						
	<b>G2-60-1342 TT27</b>	55 x 27	4	42	No	A,B	439
	<u>Aluminum Platforms</u>						
	<b>G2-60-1342 EA27</b>	55 x 27	6	42	No	A,B	395
	<b>G2-60-1342 EA38</b>	55 x 38	6	42	Yes	A,B	421
	<b>G2-60-1342 EA48 <sup>2</sup></b>	55 x 48	6	42	Yes	A,B	442
<u>Bar Grate Platform</u>							
<b>G2-60-1342 BG27</b>	55 x 27	4	42	No	A,B	445	
<b>1500 lb. Capacity</b>	<u>Treadplate Platforms</u>						
	<b>G2-60-1542 TP27</b>	55 x 27	4	42	No	B	438
	<b>G2-60-1542 TP38</b>	55 x 38	4	42	Yes	B	478
	<b>G2-60-1542 TP42</b>	55 x 42	7	42	Yes	B	503
	<u>TommyTraction™ Platform</u>						
	<b>G2-60-1542 TT27</b>	55 x 27	4	42	No	B	439
	<u>Aluminum Platforms</u>						
	<b>G2-60-1542 EA27</b>	55 x 27	6	42	No	B	395
	<b>G2-60-1542 EA38</b>	55 x 38	6	42	Yes	B	421
	<b>G2-60-1542 EA48 <sup>2</sup></b>	55 x 48	6	42	Yes	B	442
<u>Bar Grate Platform</u>							
<b>G2-60-1542 BG27</b>	55 x 27	4	42	No	B	445	
<b>G2 MODELS FOR MID-SIZED PICKUPS</b>							
<b>750 lb. Capacity</b>	<u>Treadplate Platforms</u>						
	<b>G2-54-7542 TP38 <b>NEW</b></b>	49 x 38	4	42	Yes	G	421
	<u>Aluminum Platforms</u>						
<b>G2-54-7542 EA38 <b>NEW</b></b>	50 x 38	6	42	Yes	G	369	

**G2 SERIES DIMENSIONS <sup>3</sup>**

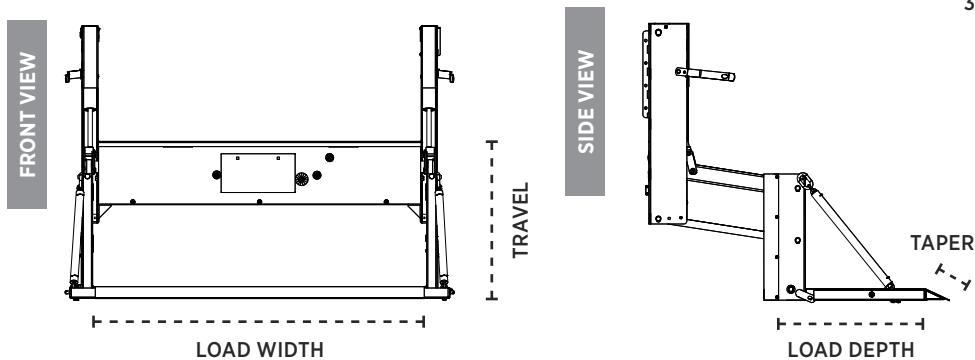

1. See applications on page 55.
2. EA48 platform extends 10" above top of liftgate mainframe. See image on page 15.
3. For detailed dimensions, visit [www.tommygate.com](http://www.tommygate.com)



## ORIGINAL SERIES



### THE ORIGINAL TOMMY LIFT

The Original Series is a single-cylinder, parallel-arm design based on a cable and pulley system. The classic pickup lift.

### ORIGINAL SERIES ADVANTAGES

Tried and true reliability. Original Series models have been used by a wide variety of commercial industries over the past fifty years. Constructed with the same high-quality pumps and motors found in all other Tommy Gate lifts, Original Series liftgates use military aircraft-grade cable for added strength.



Throughout the last 50 years the Original Series has been a staple in the liftgate industry. Invented by Delbert "Bus" Brown, and first sold for pickups in 1965, the assembly process used in constructing Original Series liftgates has not changed much over the years. Although components have been upgraded, the basic design is essentially the same. Built by hand, by master welders, machinists, and quality control experts, the exceptional quality of Tommy Gate hydraulic lifts is seen in every liftgate that leaves the Woodbine, Iowa factory.

### ORIGINAL SERIES FEATURES

- Durable, military aircraft quality lifting cables
- Fully-enclosed hydraulic system safely encased within liftgate mainframe
- Pressure bypass prevents overloading
- Fold-down platform for dock or forklift loading
- Timed inactivity switch



## SPECS

PICKUP — ORIGINAL SERIES

## AVAILABLE MODELS

ONE-YEAR STANDARD WARRANTY

	Model Number	Load Area	Taper	Travel	Platform Fold	Application <sup>1</sup>	Gate Weight
1000 lb. Capacity	Treadplate Platforms						
	<b>60-1040 TP27</b>	58 x 27	none	40	No	A, B	365
	<b>60-1040 TP38</b>	58 x 38	4	40	Yes	A, B	420
	TommyTraction™ Platform						
	<b>60-1040 TT27</b>	58 x 27	none	40	No	A, B	360
	Aluminum Platform						
<b>60-1040 EA39</b>	55 x 39	6	40	Yes	A, B	385	

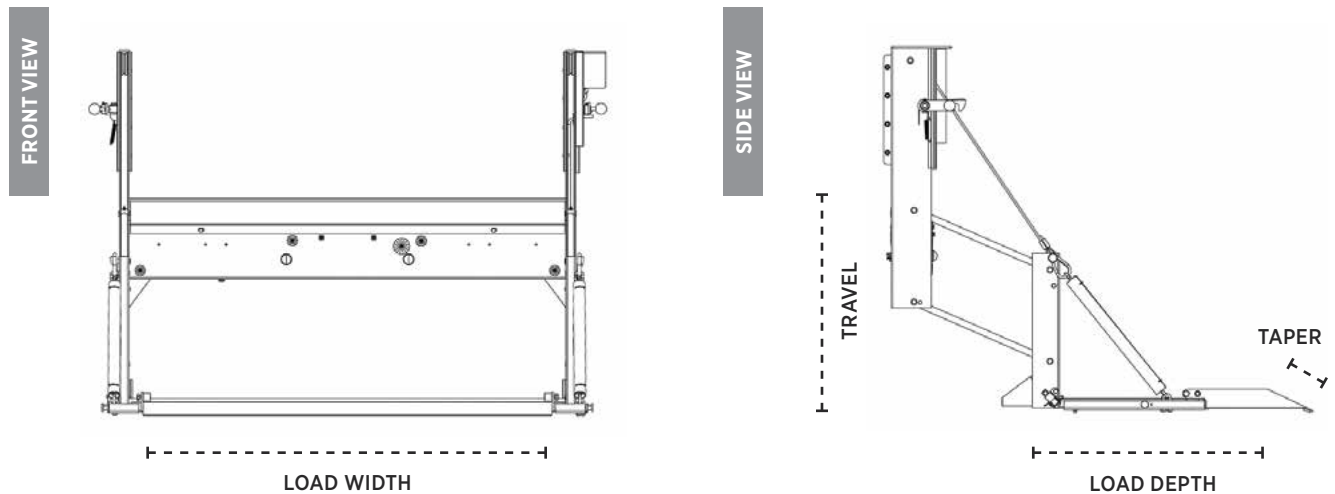
ORIGINAL SERIES DIMENSIONS <sup>2</sup>

## COMPACT PICKUP LIFTGATES

Tommy Gate Original Series liftgates fit many compact pickup trucks, not shown above. Visit [www.tommygate.com](http://www.tommygate.com) to learn more about model "MINI" liftgates.

1. See applications on page 55.
2. For detailed dimensions, visit [www.tommygate.com](http://www.tommygate.com)

FEATURES & OPTIONS

PICKUP

STANDARD FEATURES



	Fixed and Timed Toggle Control	●	●
	Recessed Control	●	-
	Vehicle-specific Mounting Brackets	●	●
	Power Cable with Full-length Ground	●	●
	Spare Tire Access	●	●
	150-amp Circuit Breaker	●	●
	Maintenance-free Pins and Bushings	●	-
	Drop-away Platform	●	-
	Hitch Compatible	● <sup>1</sup>	● <sup>1</sup>

AVAILABLE OPTIONS



	Remote Pendant Control	●	●
	Dual Controls	●	●
	Rubber Platform Bumpers	●	●
	Bolt-on Light Kit (Incandescent or LED)	●	-
	Bolt-on Light Kit (incandescent or LED)	-	●
	Folding Tire Rack	● <sup>2</sup>	● <sup>2</sup>
	Galvanized Frame and Platform	● <sup>3</sup>	-
	Rear Camera and Sensor Bar	●	●

- Standard
- Optional
- Not Available

1. Compatible with many hitches. Visit [www.tommygate.com](http://www.tommygate.com) to view complete hitch chart.
2. Not compatible with folding platforms. See spec charts.
3. Galvanized option not available with Steel Treadplate platforms. Call factory for ordering details.

# PLATFORMS PICKUP

## PLATFORM MATERIALS



	Steel Treadplate	●	●
	Extruded Aluminum	●	●
	TommyTraction	●	●
	Steel Bargrate	●	-

## EXTRUDED ALUMINUM (G2 SERIES MODELS SHOWN)

EA27 - 27" Loading Depth



EA38 - 38" Loading Depth



EA48 - 48" Loading Depth (EXTENDS ABOVE TRUCK BOX)



## STEEL PLATFORMS (G2 SERIES MODELS SHOWN)

TP27 - 27" Loading Depth



TP38 - 38" Loading Depth



TP42 - 42" Loading Depth



## G2-SERIES GALVANIZING OPTION

A high-quality galvanized finish supports long-lasting performance and appearance in even the most extreme climate conditions.

*NOT AVAILABLE WITH STEEL TREADPLATE PLATFORMS. CALL FACTORY FOR ORDERING DETAILS.*



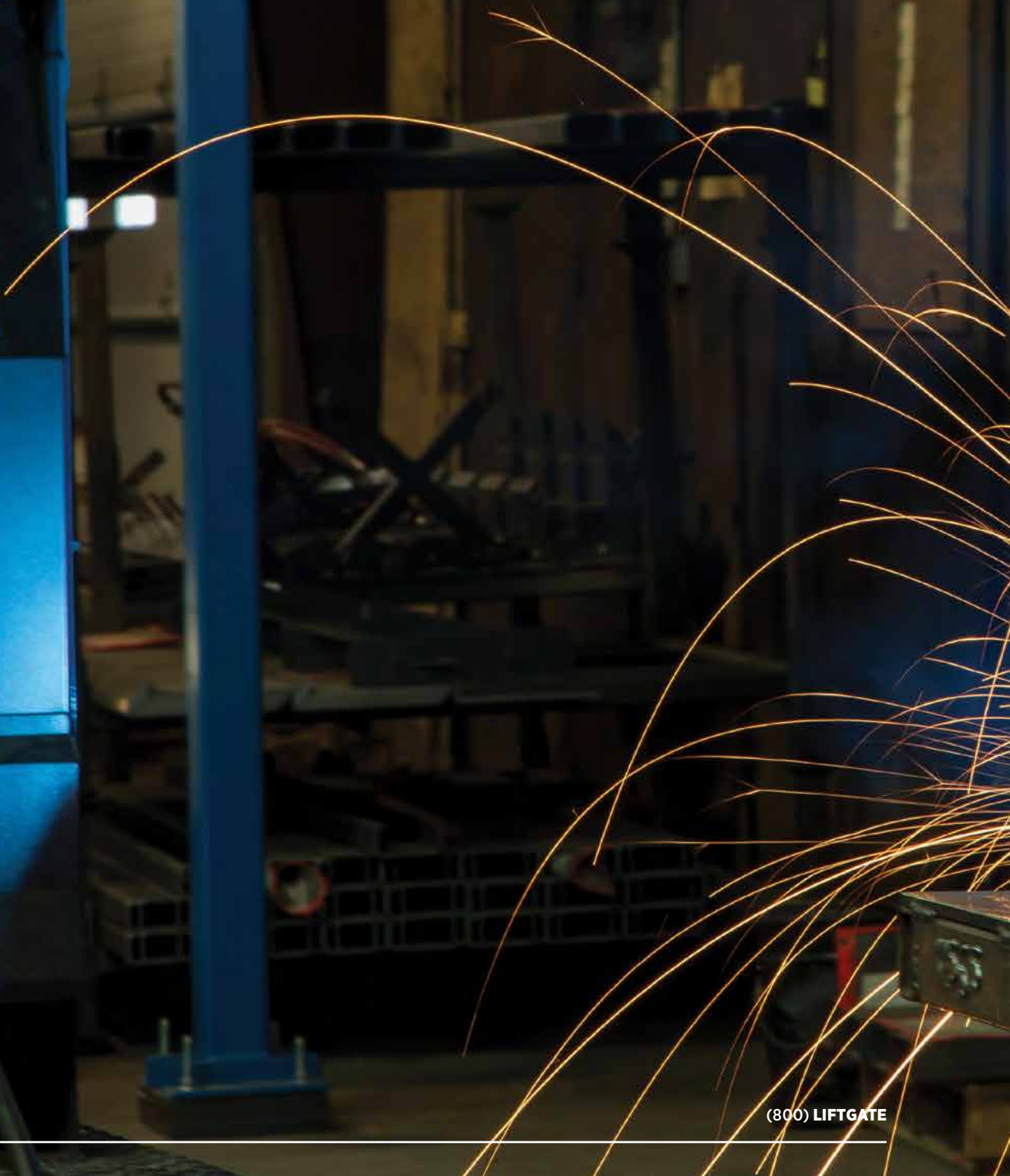



ESTD 1965



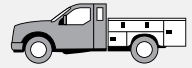

### THE SECOND GENERATION

The Tommy Gate G2 Series is a dual-cylinder, parallel-arm design which utilizes a pair of hydraulic cylinders to lower and raise the lift by applying direct power to both sides of the platform. With forty-two inches of vertical travel, the G2 Series is a great fit for most any service body.

#### ◀ G2-54-1642 TP38

*Shown with discontinued recessed light kit. Recessed lights have been replaced by a bolt-on kit.*

Hydraulic cylinders are built in-house. Precision cylinder welds are executed by robotic machines, while assembly and testing are done by hand.



### G2 SERIES LIFTGATE FEATURES

- Dual hydraulic cylinders
- Virtually maintenance-free components
- Recessed control
- Larger platforms
- Fully-enclosed hydraulic system located within the liftgate mainframe



Dual-drive liftgates provide increased durability for rigorous cycling and have low maintenance requirements. A paint-before-assembly process also increases the longevity of the lift's aesthetics.



### MODELS FOR SERVICE BODIES WITH 48" OPENING

TWO-YEAR STANDARD WARRANTY

	Model Number	Load Area	Taper	Travel	Platform Fold	Gate Weight
1300 lb. Capacity	Treadplate Platforms					
	G2-54-1342 TP27	49 x 27	4	42	No	415
	G2-54-1342 TP38	49 x 38	4	42	Yes	453
	G2-54-1342 TP42	49 x 42	7	42	Yes	477
	TommyTraction™ Platform					
	G2-54-1342 TT27	50 x 27	4	42	No	416
	Aluminum Platforms					
	G2-54-1342 EA27	49 x 27	6	42	No	375
	G2-54-1342 EA38	49 x 38	6	42	Yes	399
	G2-54-1342 EA48 <sup>1</sup>	49 x 48	6	42	Yes	419
Bar Grate Platform						
G2-54-1342 BG27	50 x 27	4	42	No	422	
1600 lb. Capacity	Treadplate Platforms					
	G2-54-1642 TP27	49 x 27	4	42	No	415
	G2-54-1642 TP38	49 x 38	4	42	Yes	453
	G2-54-1642 TP42	49 x 42	7	42	Yes	477
	TommyTraction™ Platform					
	G2-54-1642 TT27	50 x 27	4	42	No	416
	Aluminum Platforms					
	G2-54-1642 EA27	49 x 27	6	42	No	375
	G2-54-1642 EA38	49 x 38	6	42	Yes	399
	G2-54-1642 EA48 <sup>1</sup>	49 x 48	6	42	Yes	419
Bar Grate Platform						
G2-54-1642 BG27	50 x 27	4	42	No	422	

### ADDITIONAL BODY SIZES

Body Opening	Model	Description
54"	60SB	55" Load Area width

1. See applications on page 55.
2. EA48 platform extends 10" above top of liftgate mainframe. See image on page 23.
3. For detailed dimensions, visit [www.tommygate.com](http://www.tommygate.com)

### G2 SERIES DIMENSIONS <sup>3</sup>

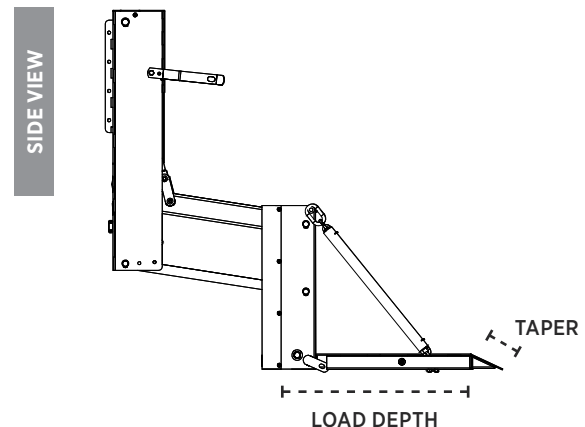
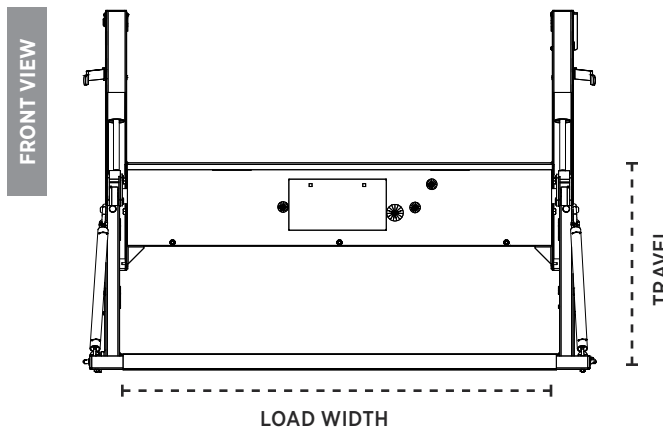



**ORIGINAL SERIES**



**THE ORIGINAL TOMMY LIFT**

The Original Series is a single-cylinder, parallel-arm design based on a cable and pulley system. The classic pickup lift.

**ORIGINAL SERIES ADVANTAGES**

Tried and true reliability. Original Series models have been used by a wide variety of commercial industries over the past fifty years. Constructed with the same high-quality pumps and motors found in all other Tommy Gate lifts, Original Series liftgates use military aircraft-grade cable for added strength.



The state-of-the-art Tommy Gate factory houses six different assembly lines as well as developmental engineering and testing departments and is located on the same piece of ground where every Tommy Gate hydraulic lift has been produced for over 50 years.

**ORIGINAL SERIES FEATURES**

- Durable, military aircraft quality lifting cables.
- Fully-enclosed hydraulic system safely encased within liftgate mainframe
- Pressure bypass prevents overloading
- Fold-down platform for dock or forklift loading
- Timed inactivity switch



**SPECS**

**SERVICE BODY — ORIGINAL SERIES**

**MODELS FOR SERVICE BODIES WITH 48" OPENING**

ONE-YEAR STANDARD WARRANTY

	Model Number	Load Area	Taper	Travel	Platform Fold	Gate Weight
<b>1000 lb. Capacity</b>	Treadplate Platforms					
	<b>54-1040 TP27</b>	52 x 27	none	40	No	335
	<b>54-1040 TP38</b>	52 x 38	4	40	Yes	385
	TommyTraction™ Platform					
	<b>54-1040 TT27</b>	52 x 27	none	40	No	330
	Aluminum Platform					
	<b>54-1040 EA39</b>	49 x 39	6	40	Yes	355

**ADDITIONAL BODY SIZES**

Body Opening	Model	Description
<b>54"</b>	<b>60SB</b>	55" Load Area width

**ORIGINAL SERIES DIMENSIONS <sup>2</sup>**

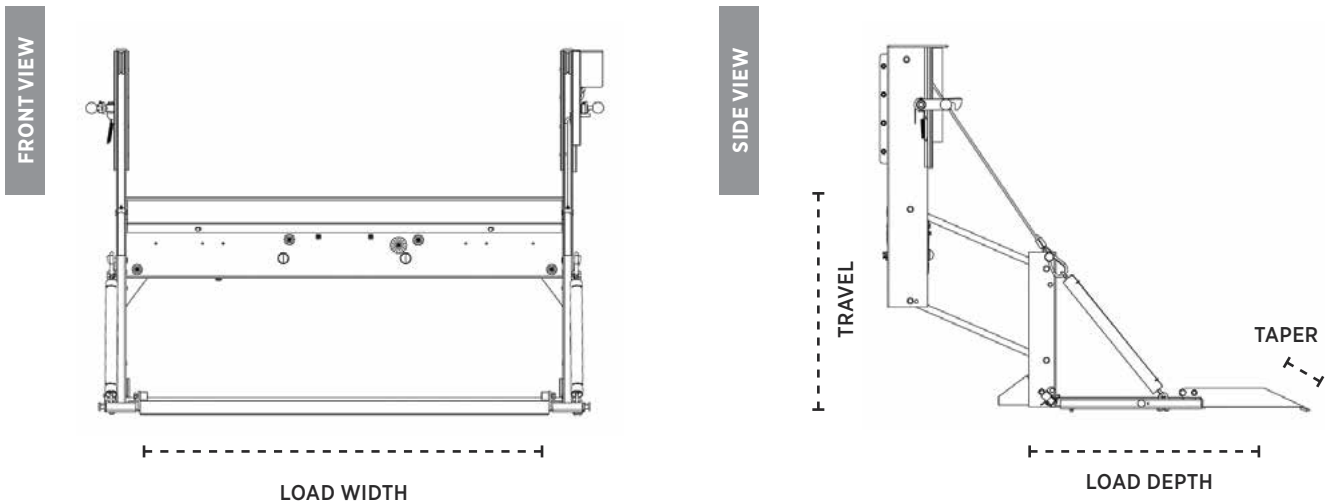

1. See applications on page 55.  
 2. For detailed dimensions, visit [www.tommygate.com](http://www.tommygate.com)

FEATURES & OPTIONS

SERVICE BODY

STANDARD FEATURES



	Fixed and Timed Toggle Control	●	●
	Recessed Control	●	-
	Vehicle-specific Mounting Brackets	●	●
	Power Cable with Full-length Ground	●	●
	150-amp Circuit Breaker	●	●
	Maintenance-free Pins and Bushings	●	-
	Drop-away Platform	●	-
	Hitch Compatible	● <sup>1</sup>	● <sup>1</sup>

AVAILABLE OPTIONS



	Remote Pendant Control	●	●
	Dual Controls	●	●
	Rubber Platform Bumpers	●	●
	Bolt-on Light Kit (Incandescent or LED)	●	-
	Bolt-on Light Kit (incandescent or LED)	-	●
	Folding Tire Rack	● <sup>2</sup>	● <sup>2</sup>
	Galvanized Frame and Platform	● <sup>3</sup>	-

- Standard
- Optional
- Not Available

1. Compatible with many hitches. Visit [www.tommygate.com](http://www.tommygate.com) to view complete hitch chart.
2. Not compatible with folding platforms. See spec charts.
3. Galvanized option not available with Steel Treadplate platforms. Call factory for ordering details.



# PLATFORMS SERVICE BODY

## PLATFORM MATERIALS



	Steel Treadplate	●	●
	Extruded Aluminum	●	●
	TommyTraction	●	●
	Steel Bargrate	●	-

## EXTRUDED ALUMINUM (G2 SERIES MODELS SHOWN)

### EA38 - 38" Loading Depth



### EA48 - 48" Loading Depth (EXTENDS ABOVE TRUCK BOX)

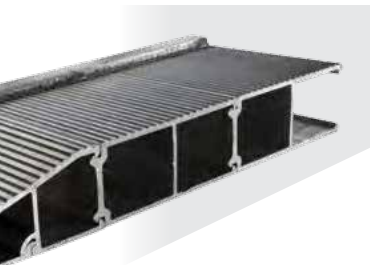
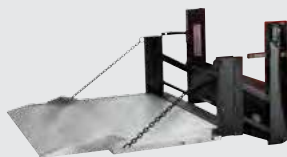

ALUMINUM PLATFORMS ARE COMPRISED OF INTERLOCKING, 6061-T6 AIRCRAFT-QUALITY EXTRUSIONS.

## STEEL PLATFORMS (G2 SERIES MODELS SHOWN)

### TP27 - 27" Loading Depth



### TP38 - 38" Loading Depth



PLATFORM DROP-CHAIN COVERS PROVIDE A QUIETER RIDE.



## G2-SERIES GALVANIZING OPTION

A high-quality galvanized finish supports long-lasting performance and appearance in even the most extreme climate conditions.

*NOT AVAILABLE WITH STEEL TREADPLATE PLATFORMS. CALL FACTORY FOR ORDERING DETAILS.*









**FLATBED, STAKE, & VAN BODY**

2500 & 3000 LBS CAPACITY

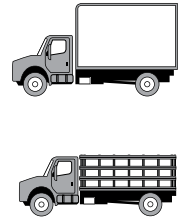

**TUCKUNDER  
SERIES**

**TKT MODELS**

TKT models address all the concerns a liftgate operator faces. With self-leveling and power down functions, the lift is simple to use and reliable. The large platforms easily accommodate pallet-sized loads. And, the wide-arm, dual-cylinder design assures sturdy and consistent lifting action.



TKT Models are outfitted with numerous design features including hydraulic power-down and self-leveling actions for optimal control, a molded-plastic power unit cover that protects vital parts from outside elements, and a low-profile control with 5-minute inactivity shut-off to guard against unauthorized usage.



TKT-80-30 EA60



**BED EXTENSIONS**

All Tuckunder Series liftgates come with a separate bed extension. Both “standard” strength, 3/16-inch, steel construction bed extensions and “heavy duty” strength, 3/8-inch, versions are available.

All Tommy Gate Tuckunder Series bed extensions come with standard 24-inch, rubber dock bumpers and bolt-on adjustable steps.

# SPECS

## FLATBED, STAKE, & VAN — TUCKUNDER SERIES

### AVAILABLE MODELS (DUAL-CYLINDER, POWER-DOWN, SELF-LEVELING)

TWO-YEAR STANDARD WARRANTY

	Model Number	Load Area	Bed Heights <sup>1</sup>	Gate Weight <sup>2</sup>
2500 lb. Capacity	Treadplate Platforms			
	TKT-80-25 TP50	80 x 50	40-54	887
	TKT-80-25 TP60	80 x 60	45-54	980
	Aluminum Platforms			
	TKT-80-25 EA50	80 x 50	40-54	816
	TKT-80-25 EA60	80 x 60	45-54	866
3000 lb. Capacity	Treadplate Platforms			
	TKT-80-30 TP50	80 x 50	40-54	887
	TKT-80-30 TP60	80 x 60	45-54	980
	Aluminum Platforms			
	TKT-80-30 EA50	80 x 50	40-54	816
	TKT-80-30 EA60	80 x 60	45-54	866

### AVAILABLE BED EXTENSION OPTIONS

Body Size	Extension Type	Extension Weight	Description
96"	Standard	276	"standard" strength 3/16-inch thick steel construction
96"	Heavy Duty	334	"heavy duty" strength 3/8-inch thick steel construction
102"	Standard	283	"standard" strength 3/16-inch thick steel construction
102"	Heavy Duty	341	"heavy duty" strength 3/8-inch thick steel construction

### TKT MODEL DIMENSIONS <sup>3</sup>

1. Minimum bed heights (laden), Maximum bed heights (unladen).
2. Must add bed extension weight for total gate weight.
3. For detailed dimensions, visit [www.tommygate.com](http://www.tommygate.com)

ABOVE VIEW

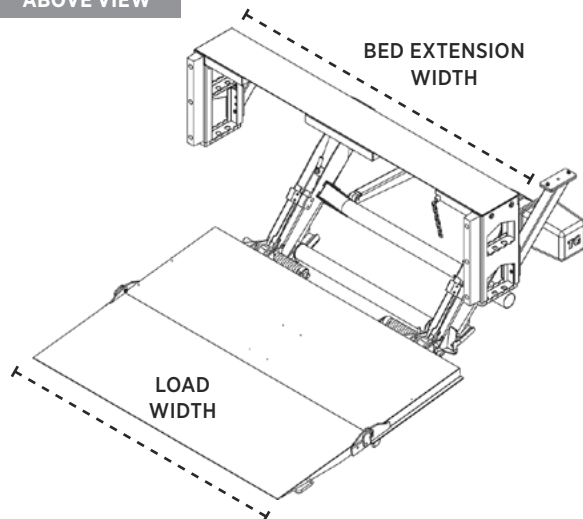



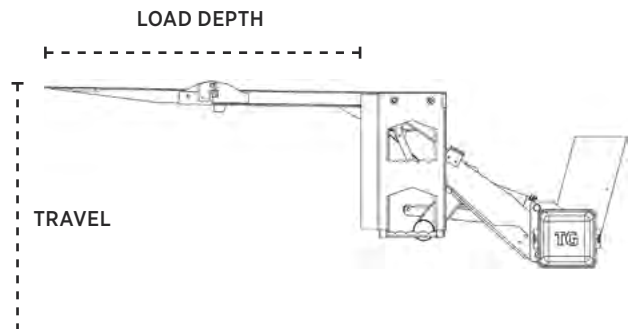



SIDE VIEW









FEATURES & OPTIONS

FLATBED, STAKE, & VAN — TUCKUNDER SERIES

STANDARD FEATURES

	Power Down
	Underride Impact Guard
	Low-profile, Fixed Toggle Control
	Snubber Kit
	Standard, 38 ft., Power Cable with Full-length Ground
	24-inch, Rubber Dock Bumpers
	Bolt-on Adjustable Steps

AVAILABLE OPTIONS

	Split Cart Stops <sup>1</sup>
	2-Light, LED Light Kit
	Dual Controls
	Extended, 41 ft., Power Cable with Full-length Ground
	24-volt System
	In-Line Power Shut-Off
	License Plate Mount

1. Extruded Aluminum platforms lose 10 inches of loading depth when cart stops are deployed.

Like all Tommy Gate hydraulic lifts, the main assembly of the Tuckunder Series is cut from raw steel, formed into precision parts, and hand-welded. TKT models are then **painted before assembly** to reduce exposure and corrosion. This entire process is completed on site at the Tommy Gate factory in Woodbine, Iowa.



# PLATFORMS

FLATBED, STAKE, & VAN — TUCKUNDER SERIES

## PLATFORM MATERIALS



Steel Treadplate



Extruded Aluminum

## PLATFORMS

Both the extruded aluminum and treadplate steel platforms have clean, flat loading areas. Aluminum platforms also utilize a flat platform hinge for maximum convenience.



## SPLIT CART STOPS

Aluminum platforms are available with foot-activated, dual cart stops. Platform loses 10 inches of loading depth when the cart stops are deployed.

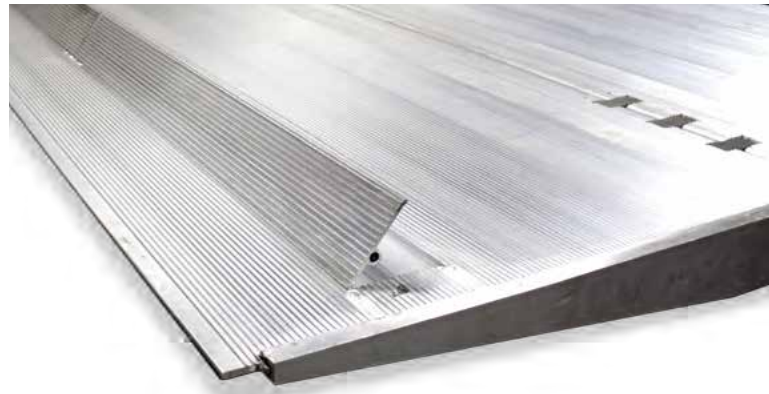

## EASY-TO-HANDLE PLATFORMS

All TKT Models are equipped with coiled torsion springs in both the main platform and “flipper” hinge points to make the folding and unfolding of Tuckunder Series platforms as easy as possible.

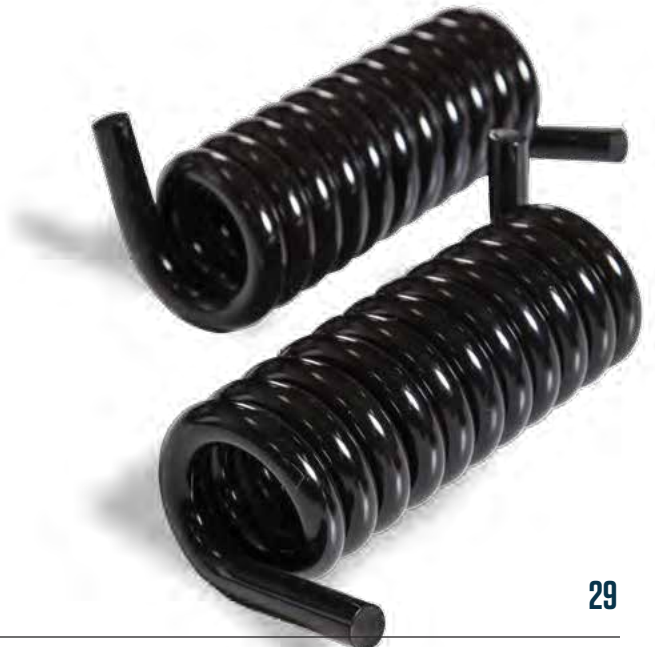



**RAILGATE SERIES  
HIGH-CYCLE MODELS WITH BI-FOLD PLATFORMS**



**BI-FOLD RAILGATE MODELS**

The most versatile, dependable liftgates ever seen in a loading bay, Bi-Fold, High-Cycle models support large steel platforms and high lifting capacities while still remaining completely dock-compatible. The platform drop-down function allows work vehicles to load and unload in any manner at any location.

◀ 89-30 BF TP70

In the drop-away position, Bi-Fold Railgate platforms rest at bed height, allowing seamless dock compatibility.

The Low-Profile Control, a standard feature on all High-Cycle Railgates, includes an inactivity shut-off to guard against unauthorized use.



**BI-FOLD RAILGATE FEATURES**

- A SAFETY-TRIP BAR** disengages the lift when an object is detected between the rising platform and the liftgate mainframe
- B LOW-PROFILE CONTROL** reduced size simplifies operation
- C SELF-CLOSE ARM** cam-arm system opens/closes the platform automatically

**SPECS**

**FLATBED, STAKE, & VAN — RAILGATE SERIES**

**BI-FOLD, HIGH-CYCLE MODELS FOR 96- & 102-INCH WIDE BODIES<sup>1</sup>**

TWO-YEAR STANDARD WARRANTY

	Model Number	Body	Load Area	Taper <sup>2</sup>	Bed Heights <sup>3</sup>	Gate Weight
<b>2500 lb. Capacity</b>	Treadplate Platforms					
	<b>89-25 BF TP60</b>	96	83 x 60	13	34 - 54	1320
	<b>89-25 BF TP70</b>	96	83 x 70	13	38 - 54	1378
	<b>95-25 BF TP60</b>	102	89 x 60	13	34 - 54	1362
	<b>95-25 BF TP70</b>	102	89 x 70	13	38 - 54	1420
<b>3000 lb. Capacity</b>	Treadplate Platforms					
	<b>89-30 BF TP60</b>	96	83 x 60	13	34 - 54	1320
	<b>89-30 BF TP70</b>	96	83 x 70	13	38 - 54	1378
	<b>95-30 BF TP60</b>	102	89 x 60	13	34 - 54	1362
	<b>95-30 BF TP70</b>	102	89 x 70	13	38 - 54	1420

**BI-FOLD, HIGH-CYCLE RAILGATE DIMENSIONS**

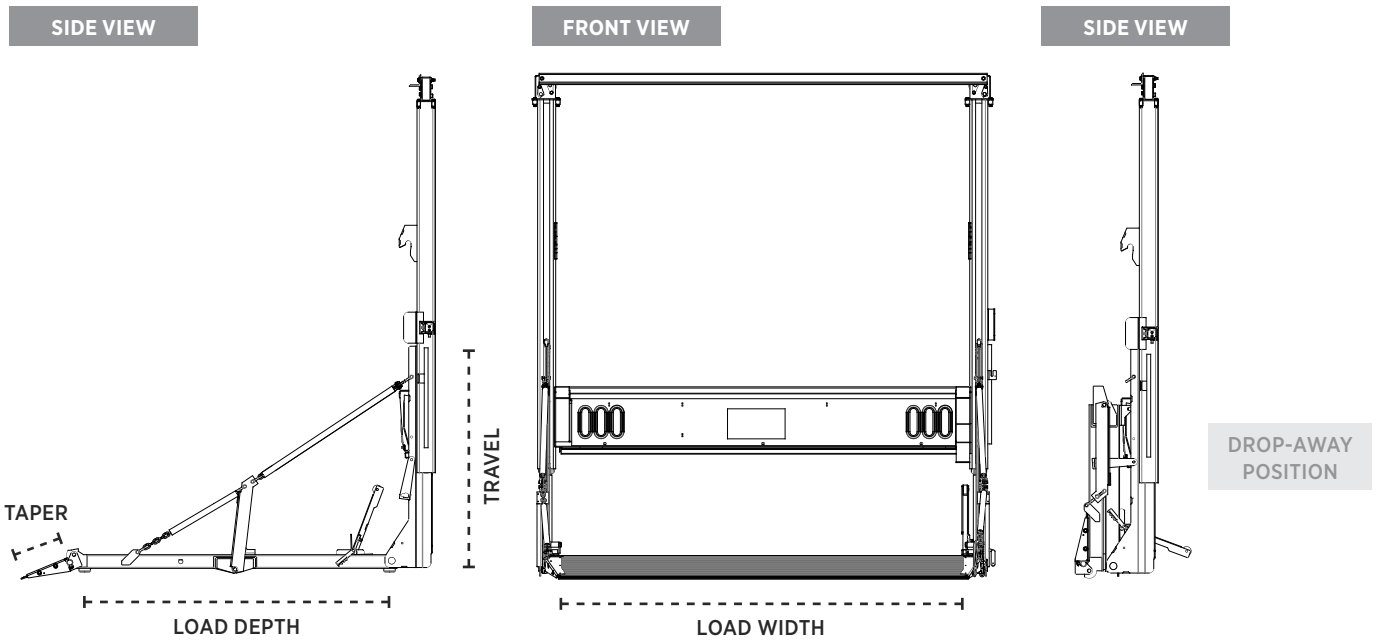

**IMPORTANT**

High-cycle railgate models are intended for use on medium-duty trucks only.

1. Bi-Fold, High-Cycle configurations for additional body widths may be available. Contact factory for details.
2. Standard, aluminum retention ramp serves as 13-inch, folding, platform taper on Bi-Fold Railgate models.
3. Minimum bed heights (laden), Maximum bed heights (unladen).

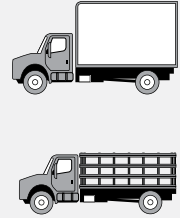

**RAILGATE SERIES  
HIGH-CYCLE MODELS WITH FIXED PLATFORMS**

**HIGH-CYCLE RAILGATE MODELS**

High-cycle models apply a steel roller and leaf-chain pulley system to maximize smoothness of motion, endurance, and strength. This medium-duty railgate is ideal for high-cycle applications in any environment. These lifts are built with the highest quality components and place a priority on function and safety.

89-30 EA55 ▶

*Shown with discontinued control box. High-cycle railgate models now come standard with low-profile control. See page 34.*



High-cycle railgates come standard with safety trip bar, auto open and close, and recessed lights. Taper-integrated cart stops are optional on extruded-aluminum platform models.



**ROLLERS**

Steel rollers guide the platform vertically within the rail track and are designed to withstand intensive cycling. Dual sealed, maintenance-free ball bearings ensure the rollers are long-lasting and perform consistently in all climate conditions.





# SPECS

## FLATBED, STAKE, & VAN — RAILGATE SERIES

### FIXED-PLATFORM, HIGH-CYCLE MODELS FOR 96" WIDE BODIES

TWO-YEAR STANDARD WARRANTY

	Model Number	Body	Load Area	Taper	Bed Heights	Gate Weight
2500 lb. Capacity	Treadplate Platforms					
	89-25 TP36	96	89 x 36	12	32 - 54	1040
	89-25 TP42	96	89 x 42	12	32 - 54	1094
	89-25 TP48	96	89 x 48	12	32 - 54	1147
	Aluminum Platforms <sup>1</sup>					
	89-25 EA55	96	89 x 55	12	32 - 54	968
3000 lb. Capacity	Treadplate Platforms					
	89-30 TP36	96	89 x 36	12	32 - 54	1040
	89-30 TP42	96	89 x 42	12	32 - 54	1094
	89-30 TP48	96	89 x 48	12	32 - 54	1147
	Aluminum Platforms <sup>1</sup>					
	89-30 EA55	96	89 x 55	12	32 - 54	968

### ADDITIONAL BODY SIZES

Body Size	Model	Load Width
90"	85	85
102"	95	95

### IMPORTANT

High-cycle railgate models are intended for use on medium-duty trucks only.



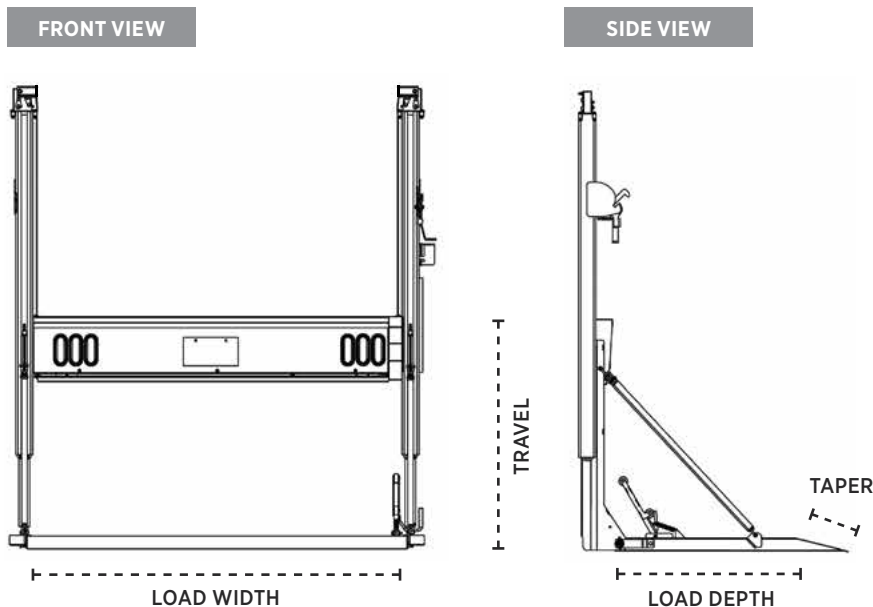

1. See additional aluminum platform depths on page 35.
2. For detailed dimensions, visit [www.tommygate.com](http://www.tommygate.com)





### HIGH-CYCLE RAILGATE DIMENSIONS <sup>2</sup>

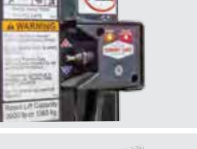
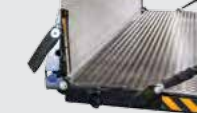

FEATURES & OPTIONS

HIGH-CYCLE RAILGATE MODELS

STANDARD FEATURES		BI-FOLD MODELS	FIXED PLATFORM MODELS
	Steel Rollers	●	●
	Safety-trip Bar	●	●
	Self-close System	●	●
	Recessed Lights	●	●
	Low-profile Control	●	●
	13" Retention Ramp	●	-

AVAILABLE OPTIONS		BI-FOLD MODELS	FIXED PLATFORM MODELS
	Above Bed Travel	●	●
	Recessed LED Lights	●	●
	Dual Controls (w/ pendant)	●	●
	Split Cart Stops	-	●
NO IMAGE	In-cab Shut Off	●	●

- Standard
- Optional
- Not Available

Tommy Gate's engineering and quality control programs uphold the highest standards at each stage of the assembly process: every new product undergoes strenuous cycle testing, every pump and motor is tested before it is sent into production, and all welding and assembly processes are checked, double checked, and must pass a final inspection according to strict quality assurance guidelines.



# PLATFORMS

## HIGH-CYCLE RAILGATE MODELS

### PLATFORM MATERIALS

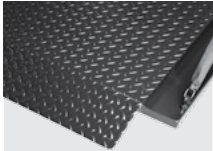
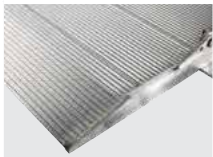
		BI-FOLD MODELS	FIXED PLATFORM MODELS
	Steel Treadplate	●	●
	Extruded Aluminum	-	●

### ALUMINUM PLATFORM DEPTHS

Extruded aluminum platforms (on fixed platform models) are available in any depth, 35" – 70", in 5" increments. Platforms are comprised of interlocking extrusions of 6061-T6 aircraft-quality aluminum.



### RETENTION RAMP

Bi-Fold, High-Cycle models come standard with a 13" tapered, retention ramp.



1 ramp closes for storage

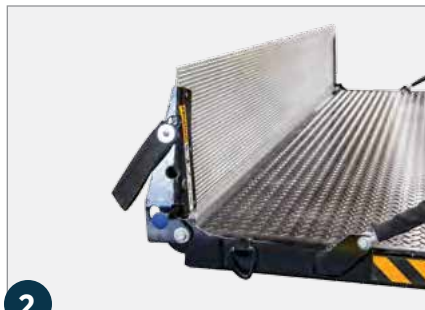

2 ramp locks at 90-degrees for cart retention

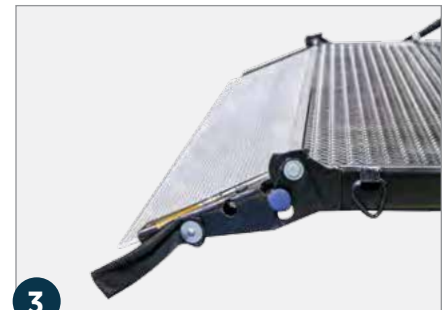

3 extended ramp hangs beyond platform level for smooth ground every time

### SPLIT CART STOPS

All railgate models with Extruded Aluminum platforms are available with taper-integrated, foot-activated, dual cart stops.



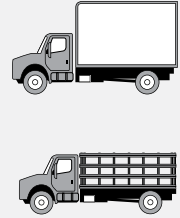

**RAILGATE SERIES**  
STANDARD MODELS WITH DOCK-FRIENDLY PLATFORMS



**DOCK-FRIENDLY RAILGATE MODELS**

Dock-friendly models feature folding RF platforms able to achieve non-obstructing positions for forklift or dock loading. Also included are a closure-assist torsion bar and maintenance-free bushings, making them some of the best liftgates ever seen in a loading bay.

◀ 89-20 RF 45-12

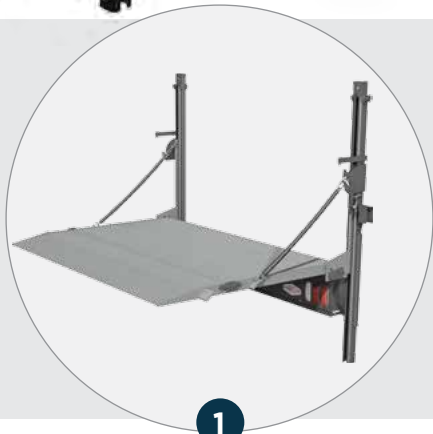

1



2



3

**PLATFORM DESCRIPTIONS**

**RF 45-6** Two-piece Extruded Aluminum w/ 45" loading depth (15" flipper) + 6" taper **(30" base height)**

**RF 45-12** Two-piece Extruded Aluminum w/ 45" loading depth (10" flipper) + 12" taper **(35" base height)**

**RF 50-6** Two-piece Extruded Aluminum w/ 50" loading depth (15" flipper) + 6" taper **(35" base height)**

Dock-friendly platforms fold and can be lowered in the vertical position to allow for easy dock or forklift loading.

**SPECS**

FLATBED, STAKE, & VAN — RAILGATE SERIES

**DOCK-FRIENDLY, STEEL-FRAME MODELS FOR 96" WIDE BODIES**

ONE-YEAR STANDARD WARRANTY

	Model Number	Load Area	Taper	Travel	Gate Weight
<b>1600 lb. Capacity</b>	Folding Aluminum Platforms				
	89-16 RF 45-6	89 x 45	6	32 - 54	674
	89-16 RF 45-12	89 x 45	12	32 - 54	688
	89-16 RF 50-6	89 x 50	6	32 - 54	695
<b>2000 lb. Capacity</b>	Folding Aluminum Platforms				
	89-20 RF 45-6	89 x 45	6	32 - 54	674
	89-20 RF 45-12	89 x 45	12	32 - 54	688
	89-20 RF 50-6	89 x 50	6	32 - 54	695

**DOCK-FRIENDLY, ALUMINUM-FRAME MODELS FOR 96" WIDE BODIES<sup>1</sup>**

	Model Number	Load Area	Taper	Travel	Gate Weight
<b>1600 lb. Capacity</b>	Folding Aluminum Platforms				
	A89-16 RF 45-6	89 x 45	6	32 - 54	550
	A89-16 RF 45-12	89 x 45	12	32 - 54	564
	A89-16 RF 50-6	89 x 50	6	32 - 54	571
<b>2000 lb. Capacity</b>	Folding Aluminum Platforms				
	A89-20 RF 45-6	89 x 45	6	32 - 54	550
	A89-20 RF 45-12	89 x 45	12	32 - 54	564
	A89-20 RF 50-6	89 x 50	6	32 - 54	571

**ADDITIONAL BODY SIZE**

Body Size	Model	Load Width
90"	85	85
102"	95	95

- Aluminum frame railgates require mounting flanges which affect installation dimensions, visit [www.tommygate.com](http://www.tommygate.com) for additional information.
- For detailed dimensions, visit [www.tommygate.com](http://www.tommygate.com)

**DOCK-FRIENDLY RAILGATE DIMENSIONS<sup>2</sup>**

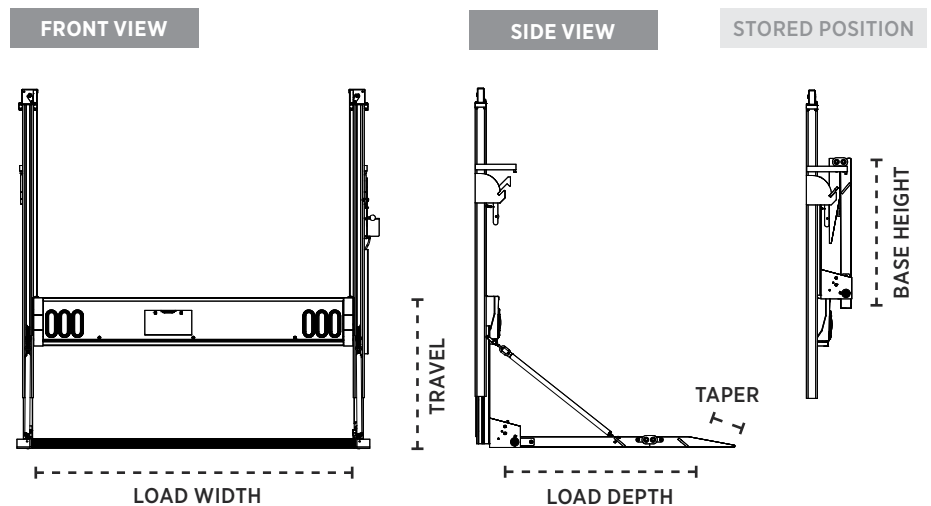

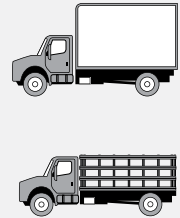

## **RAILGATE SERIES** **STANDARD MODELS WITH FIXED PLATFORMS**

### **STANDARD RAILGATE MODELS**

The Tommy Gate Railgate Series consists of expertly-engineered lifts that allow for higher weight capacities and deeper platform loading areas. Standard model railgates employ a padded-slider system and are offered in both steel and aluminum frames.



1600 and 2000 lb. capacity railgates come standard with safety trip bar, auto close, and recessed lights.

*(Optional LED light kit shown)*



### **ABOVE-BED OPTIONAL CAPABILITY**

On standard models, optional above-bed capability allows the platform to rise above the liftgate mainframe for dock loading.



### **ALL-ALUMINUM MODELS**

A corrosion-resistant, lightweight, all-aluminum frame is available for most models.



# SPECS

## FLATBED, STAKE, & VAN — RAILGATE SERIES

### STANDARD, STEEL-FRAME MODELS FOR 96" WIDE BODIES

ONE-YEAR STANDARD WARRANTY

	Model Number	Load Area	Taper	Travel	Gate Weight
1600 lb. Capacity	Treadplate Platforms				
	<b>89-16 TP37</b>	89 x 37	6	32 - 54	810
	<b>89-16 TP42</b>	89 x 42	6	32 - 54	860
	Aluminum Platforms <sup>1</sup>				
	<b>89-16 EA55</b>	89 x 55	12	32 - 54	715
2000 lb. Capacity	Treadplate Platforms				
	<b>89-20 TP37</b>	89 x 37	6	32 - 54	810
	<b>89-20 TP42</b>	89 x 42	6	32 - 54	860
	Aluminum Platforms <sup>1</sup>				
	<b>89-20 EA55</b>	89 x 55	12	32 - 54	715
	Gas Bottle Rack Platform				
	<b>89-20 GBR</b>	89 x 30	12	32 - 54	805

### STANDARD, ALUMINUM-FRAME MODELS FOR 96" WIDE BODIES <sup>2</sup>

	Model Number	Load Area	Taper	Travel	Gate Weight
1600 lb. Capacity	Aluminum Platforms <sup>1</sup>				
	<b>A89-16 EA55</b>	89 x 55	12	32 - 54	600
2000 lb. Capacity	Aluminum Platforms <sup>1</sup>				
	<b>A89-20 EA55</b>	89 x 55	12	32 - 54	600

### ADDITIONAL BODY SIZES

Body Size	Model	Load Width
80"	73	73
85"	79	79
90"	85	85
102"	95	95





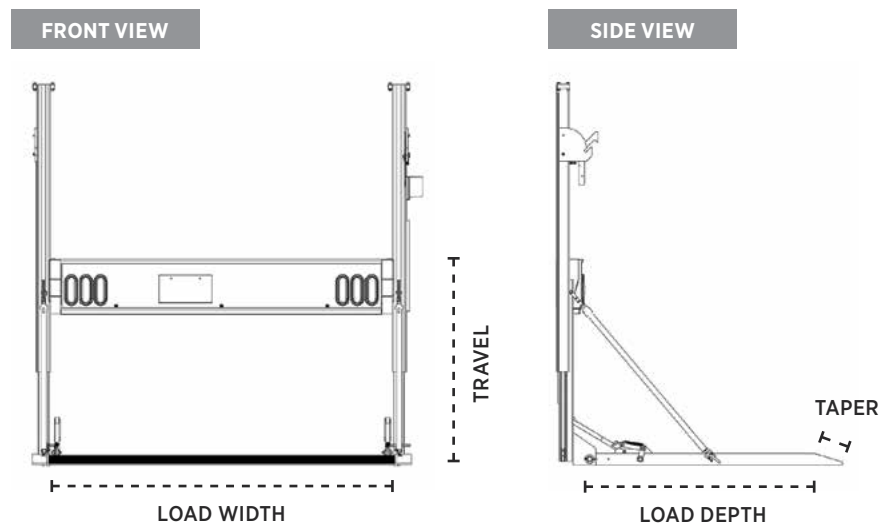

- See additional aluminum platform depths on page 41.
- Aluminum frame railgates require mounting flanges which affect installation dimensions, visit [www.tommygate.com](http://www.tommygate.com) for additional information.
- For detailed dimensions, visit [www.tommygate.com](http://www.tommygate.com)







### STANDARD RAILGATE DIMENSIONS <sup>3</sup>



FEATURES & OPTIONS

STANDARD RAILGATE MODELS

STANDARD FEATURES		DOCK-FRIENDLY MODELS	FIXED PLATFORM MODELS
	Recessed Light Kit	●	●
	Safety-trip Bar	●	●
	Self-close System	-	●
	Aluminum Sliders	●	●
	Power Cable with Full-length Ground	●	●
	Circuit Breaker	●	●
	Fixed and Timed Toggle Control	●	●

AVAILABLE OPTIONS		DOCK-FRIENDLY MODELS	FIXED PLATFORM MODELS
	Recessed LED Light Kit	●	●
	Above-bed Travel	●	●
	Dual Controls (w/ pendant)	●	●
	Taper-integrated Cart Stops	●	●
	Split Retention Ramps	-	●
	Rubber Platform Bumpers	●	●

- Standard
- Optional
- Not Available

Every pump and motor that goes into any Tommy Gate hydraulic lift must pass an assembly floor test in addition to quality control inspections by the vendor.

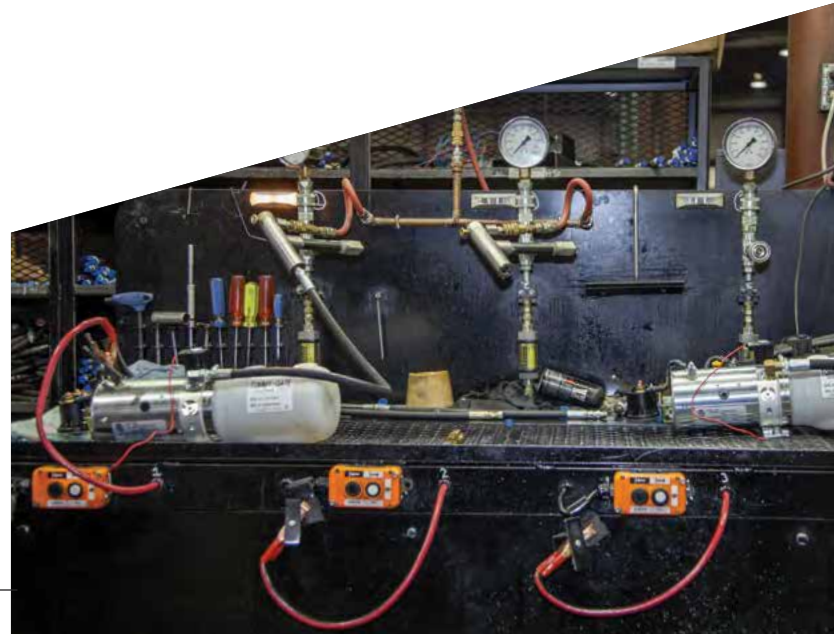



# PLATFORMS

## STANDARD RAILGATE MODELS

### PLATFORM MATERIALS

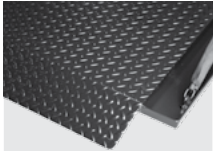
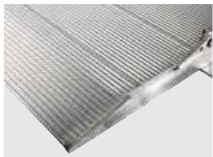
		DOCK-FRIENDLY MODELS	FIXED PLATFORM MODELS
	Steel Treadplate	-	●
	Extruded Aluminum	●	●

### SPLIT CART STOPS

All railgate models with Extruded Aluminum platforms are available with taper-integrated, foot-activated, dual cart stops.



### SPLIT RETENTION RAMPS

Steel-platforms (standard models 89 & 85 only) are available with add-on retention ramps.



### ALUMINUM PLATFORM DEPTHS

Extruded aluminum platforms (on fixed platform models) are available in any depth, 35"-70", in 5" increments. Platforms are comprised of interlocking extrusions of 6061-T6 aircraft-quality aluminum.



### GAS-BOTTLE RACK PLATFORM

GBR - 30" Loading Depth



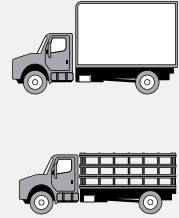

**MORE THAN A PICKUP LIFT**

The Tommy Gate G2 Series is a dual-cylinder, parallel-arm design which utilizes a pair of hydraulic cylinders to lower and raise the lift by applying direct power to both sides of the platform. Supporting larger platforms, G2 Series models are compatible with flatbed, stake and van bodies and offer a wide selection of platform materials to accommodate almost any industry application.

**G2-92-1650 TP41 ▶**

*Shown with discontinued recessed light kit. Recessed lights have been replaced by a bolt-on kit*

The G2 Series features only two grease points and the hard-chrome pins are virtually maintenance free.

Hydraulic cylinders are built in-house. Precision cylinder welds are executed by robotic machines, while assembly and testing are done by hand.

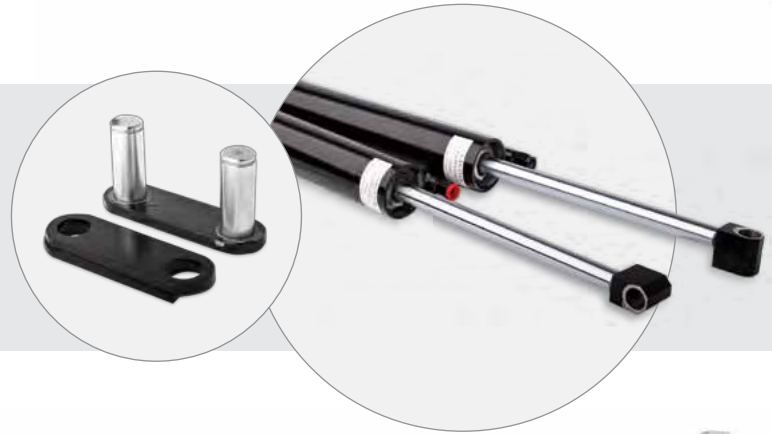

**G2 SERIES LIFTGATE FEATURES**

- Dual hydraulic cylinders
- Virtually maintenance-free components
- Recessed control
- Hitch compatibility
- Larger platforms
- Fully-enclosed hydraulic system located within the liftgate mainframe



**SPECS**

FLATBED, STAKE, & VAN — G2 SERIES

**MODELS FOR 96" WIDE BODIES**

TWO-YEAR STANDARD WARRANTY

	Model Number	Load Area	Taper	Travel	Platform Fold	Gate Weight
1300 lb. Capacity	<u>Treadplate Platforms</u>					
	<b>G2-92-1350 TP35</b>	87 x 35	6	50	No	628
	<b>G2-92-1350 TP41</b>	87 x 41	6	50	No	655
	<u>TommyTraction™ Platform</u>					
	<b>G2-92-1350 TT33</b>	87 x 33	6	50	No	612
	<u>Aluminum Platforms</u>					
	<b>G2-92-1350 EA37</b>	85 x 37	6	50	No	561
	<b>G2-92-1350 EA41</b>	85 x 41	6	50	No	577
1600 lb. Capacity	<u>Bar Grate Platform</u>					
	<b>G2-92-1350 BG33</b>	87 x 33	6	50	No	637
	<u>Treadplate Platforms</u>					
	<b>G2-92-1650 TP35</b>	87 x 35	6	50	No	628
	<b>G2-92-1650 TP41</b>	87 x 41	6	50	No	655
	<u>TommyTraction™ Platform</u>					
	<b>G2-92-1650 TT33</b>	87 x 33	6	50	No	612
	<u>Aluminum Platforms</u>					
<b>G2-92-1650 EA37</b>	85 x 37	6	50	No	561	
<b>G2-92-1650 EA41</b>	85 x 41	6	50	No	577	
LOW-PROFILE MODELS	<u>Bar Grate Platform</u>					
	<b>G2-92-1650 BG33</b>	87 x 33	6	50	No	637
	<b>G2-92-1642 TP38</b> <span style="color:red">NEW</span>	85 x 38	4	42	<b>YES</b>	609
1600 lb. Capacity	<u>Aluminum Platforms</u>					
	<b>G2-92-1642 EA38</b> <span style="color:red">NEW</span>	85 x 38	6	42	<b>YES</b>	523

NEW Low-profile G2 models feature **folding platforms** and are specifically designed to increase driver visibility and greater compatibility with additionally installed equipment.

**ADDITIONAL BODY SIZES**

Body Size	Model	Load Width
90"	87	80
85"	81	75
80"	73	66
> 67"	65	60

**G2 SERIES DIMENSIONS <sup>1</sup>**

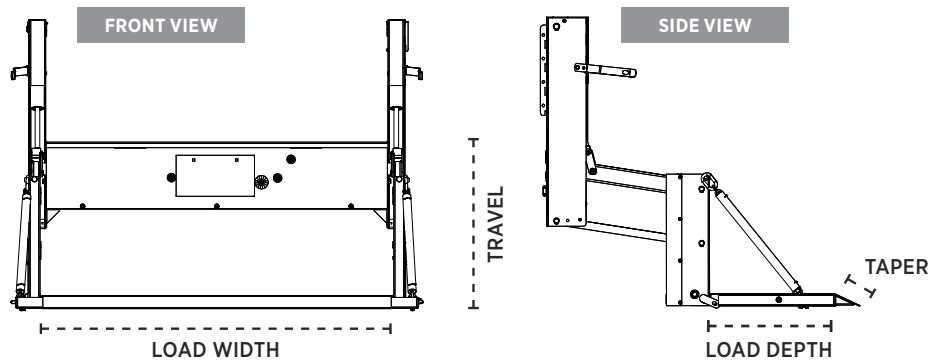

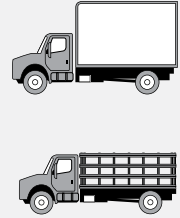

**ORIGINAL SERIES**

**THE ORIGINAL TOMMY LIFT**

The Original Series is a single-cylinder, parallel-arm design based on a cable and pulley system. This classic design is compatible with flatbed, stake and van bodies and offers a wide selection of platform materials to accommodate almost any industry application.

91-1650 TP42 ▶  
Shown with optional light kit.



The Tommy Gate facility includes a 40,000-square-foot warehouse and shipping department. Specific models are always kept in stock and ready to ship the day they are ordered. The most popular models are also kept in stock at one or more of five Tommy Gate warehouses nationwide.



**ORIGINAL SERIES FEATURES**

- Durable, military aircraft quality lifting cables.
- Fully-enclosed hydraulic system safely encased w liftgate mainframe
- Pressure bypass prevents overloading
- Fold-down platform for dock or forklift loading
- Timed inactivity switch



**SPECS**

FLATBED, STAKE, & VAN — ORIGINAL SERIES

**MODELS FOR 96" WIDE BODIES**

ONE-YEAR STANDARD WARRANTY

	Model Number	Load Area	Taper	Travel	Platform Fold	Gate Weight
<b>1000 lb. Capacity</b>	<u>Treadplate Platforms</u>					
	<b>91-1050 TP36</b>	87 x 36	6	50	No	585
	<b>91-1050 TP42</b>	87 x 42	6	50	No	610
	<u>TommyTraction™ Platform</u>					
	<b>91-1050 TT34</b>	87 x 34	6	50	No	570
	<u>Aluminum Platforms</u>					
	<b>91-1050 EA37</b>	85 x 37	6	50	No	525
	<b>91-1050 EA42</b>	85 x 42	6	50	No	540
<b>1300 lb. Capacity</b>	<u>Treadplate Platforms</u>					
	<b>91-1350 TP36</b>	87 x 36	6	50	No	585
	<b>91-1350 TP42</b>	87 x 42	6	50	No	610
	<u>TommyTraction™ Platform</u>					
	<b>91-1350 TT34</b>	87 x 34	6	50	No	570
	<u>Aluminum Platforms</u>					
	<b>91-1350 EA37</b>	85 x 37	6	50	No	525
	<b>91-1350 EA42</b>	85 x 42	6	50	No	540
<b>1600 lb. Capacity</b>	<u>Treadplate Platforms</u>					
	<b>91-1650 TP36</b>	87 x 36	6	50	No	585
	<b>91-1650 TP42</b>	87 x 42	6	50	No	610
	<u>TommyTraction™ Platform</u>					
	<b>91-1650 TT34</b>	87 x 34	6	50	No	570
	<u>Aluminum Platforms</u>					
	<b>91-1650 EA37</b>	85 x 37	6	50	No	525
	<b>91-1650 EA42</b>	85 x 42	6	50	No	540
<b>1600 lb. Capacity</b>	<u>Bar Grate Platform</u>					
	<b>91-1050 BG34</b>	87 x 34	6	50	No	585
	<u>Bar Grate Platform</u>					
	<b>91-1350 BG34</b>	87 x 34	6	50	No	585
	<u>Bar Grate Platform</u>					
	<b>91-1650 BG34</b>	87 x 34	6	50	No	585

**ADDITIONAL BODY SIZES**

Body Size	Model	Load Width
90"	86	80
85"	80	75
80"	72	66

1. For detailed dimensions, visit [www.tommygate.com](http://www.tommygate.com)

**ORIGINAL SERIES DIMENSIONS <sup>1</sup>**

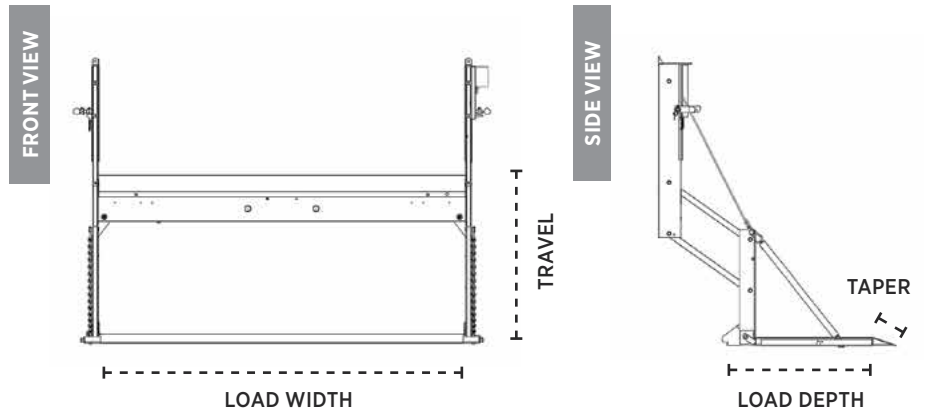



**DUMP BODY**

1600 LBS CAPACITY



**LIFT-N-DUMP™**



**DUMP-THROUGH VERSATILITY**

The Tommy Gate G2 Series is a dual-cylinder, parallel-arm design which utilizes a pair of hydraulic cylinders to lower and raise the lift by applying direct power to both sides of the platform. G2 Series Lift-N-Dump models include all the same features and functions of other G2 Series liftgates, but also offer a unique dump-through capability to be used with dump bodies.

◀ G2-92-1650 LD33



Dual hydraulic cylinders, like all G2 Series models.

Lift-N-Dump models feature pins to lock the platform in place when not in dump-through mode.

Platform latch activates the liftgate's dump-through position.

**SPECS**

DUMP BODY — G2 SERIES

**MODELS FOR BODIES WITH 83" - 88" WIDE OPENINGS**

TWO-YEAR STANDARD WARRANTY

	Model Number	Load Area	Taper	Platform Fold	Travel	Gate Weight
1600 lb. Capacity	Treadplate Platform G2-92-1650 LD33	83 x 33	6	No	50	682

**ADDITIONAL BODY SIZES**

Body Openings	Model	Load Width
78" - 83"	87	78
69" - 78"	81	73
64" - 69"	73	64

**IMPORTANT**

Use of a double-acting hoist is recommended. Using a single-acting hoist requires tie-down clamps.

Dimensions similar to Flatbed, Stake, & Van - G2 Series.









# FEATURES & OPTIONS

FLATBED, STAKE, & VAN / DUMP BODY

## STANDARD FEATURES









	Fixed and Timed Toggle Control	●	●
	Recessed Control	●	-
	Power Cable with Full-length Ground	●	●
	150-amp Circuit Breaker	●	●
	Maintenance-free Pins and Bushings	●	-
	Hitch Compatible	● <sup>1</sup>	● <sup>1</sup>

- Standard
- Optional
- Not Available

1. Compatible with many hitches.
2. Not available for Lift-N-Dump models.
3. Lift-N-Dump models only available with dump-through steel treadplate platform.
4. Galvanized option not available with Steel Treadplate platforms or for Lift-N-Dump models. Call factory for ordering details.

## AVAILABLE OPTIONS



	Remote Pendant Control	●	●
	Dual Controls	●	●
	Rubber Platform Bumpers	●	●
	Bolt-on Light Kit (Incandescent or LED)	●	-
	Bolt-on Light Kit (incandescent or LED)	-	●
	Folding Tire Rack	● <sup>2</sup>	● <sup>2</sup>
	Galvanized Frame and Platform	● <sup>4</sup>	-



# PLATFORMS

FLATBED, STAKE, & VAN / DUMP BODY

## PLATFORM MATERIALS



	Steel Treadplate	●	●
	Extruded Aluminum	●	●
	TommyTraction	●	●
	Steel Bargrate	●	●

## DROP-CHAIN COVERS

Platform drop-chain covers provide a quieter ride.



## EXTRUDED ALUMINUM

(G2 SERIES MODELS SHOWN)

### EA37 - 37" Loading Depth



## STEEL PLATFORMS

(G2 SERIES MODELS SHOWN)

### TP36 - 36" Loading Depth



### BG34 - 34" Loading Depth



### TT34 - 34" Loading Depth

(SHOWN W/ OPTIONAL TIRE RACK)







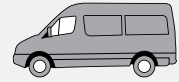

**CANTILEVER SERIES**



**THE CANTILEVER SERIES**

The Tommy Gate Cantilever Series is a modern hydraulic lift that is specifically designed to operate seamlessly with commercial vans.

The culmination of years of engineering, Cantilever Series models are highly versatile and include numerous desirable features. A bolt-on underside mount is compatible with most modern vans and eliminates the need for any welding. The platform is constructed from corrosion-resistant aluminum and folds laterally, allowing for access to the rear of the vehicle without operating the lift. Platforms support a large loadable area and come standard with dual cart stops.

The Cantilever Series features internal bridges, dual cart stops, remote pendant control, and maintenance-free components.



Easy to use and highly efficient, Cantilever Series models are aesthetically pleasing as well as logistically practical.

**LEFT:** the larger platform (EF71) features 60 inches of loading depth and is recommended for higher-roof vans only.

**RIGHT:** the smaller platform (EF52) features 40 inches of loading depth and is ideal for low-roof vans



**SPECS**

**CARGO VAN — CANTILEVER SERIES**

**AVAILABLE MODELS <sup>1</sup>**

TWO-YEAR STANDARD WARRANTY

Model Number		Load Area	Depth	Travel	Gate Wt.
<b>1300 lb. Lifting Capacity</b>	MB SPRINTER <sup>®</sup> 2007-2016 2500 All Styles / 3500 170" WB & 170" WB Ext. <sup>2</sup>				
	<b>CVL-AA-1330 EF71</b>	53 x 60	71	30	610
	<b>CVL-AA-1330 EF52</b>	53 x 40	52	30	570
	MB SPRINTER <sup>®</sup> 2007-2016 3500 144" WB. <sup>2</sup>				
	<b>CVL-AB-1330 EF71</b>	53 x 60	71	30	610
	<b>CVL-AB-1330 EF52</b>	53 x 40	52	30	570
	Nissan NV <sup>®</sup> 2011-2016				
	<b>CVL-AC-1330 EF71</b>	53 x 60	71	30	610
	<b>CVL-AC-1330 EF52</b>	53 x 40	52	30	570
	Chevrolet / GMC EXPRESS <sup>®</sup> /SAVANA <sup>®</sup> 2011-2016				
	<b>CVL-AD-1330 EF52</b>	53 x 40	52	30	570
	Ram Promaster <sup>®</sup> 2014-2016 1500/2500/3500, 118", 136", & 159"WB				
	<b>CVL-AE-1330 EF71</b>	53 x 60	71	30	610
	<b>CVL-AE-1330 EF52</b>	53 x 40	52	30	570
	Ram Promaster <sup>®</sup> 2014-2016 3500, 159"WB Extended Body (ONLY)				
	<b>CVL-AH-1330 EF71</b>	53 x 60	71	30	610
	<b>CVL-AH-1330 EF52</b>	53 x 40	52	30	570
	Ford Transit <sup>®</sup> 2015-2016 150/250/350, 130", & 148"WB <sup>3</sup>				
	<b>CVL-AF-1330 EF71</b>	53 x 60	71	30	610
	<b>CVL-AF-1330 EF52</b>	53 x 40	52	30	570
Ford Transit <sup>®</sup> 2015-2016 350, 148"WB Extended Body (ONLY) <sup>3</sup>					
<b>CVL-AG-1330 EF71</b>	53 x 60	71	30	610	
<b>CVL-AG-1330 EF52</b>	53 x 40	52	30	570	

1. Installation may affect specific vehicle features such as rear sensors and back-up cameras. Installation also requires the spare tire to be relocated and is not compatible with any form of towing hitch.
2. Mercedes-Benz requires the use of an auxiliary battery for all liftgates installed on SPRINTER<sup>®</sup> vans.
3. Ford Transit<sup>®</sup> "medium-height" models are compatible with EF71 platform. Some Ford Transit<sup>®</sup> installations may require a separate connection point kit to be ordered from Ford. See Install Instructions or contact customer service.

**CANTILEVER SERIES DIMENSIONS**

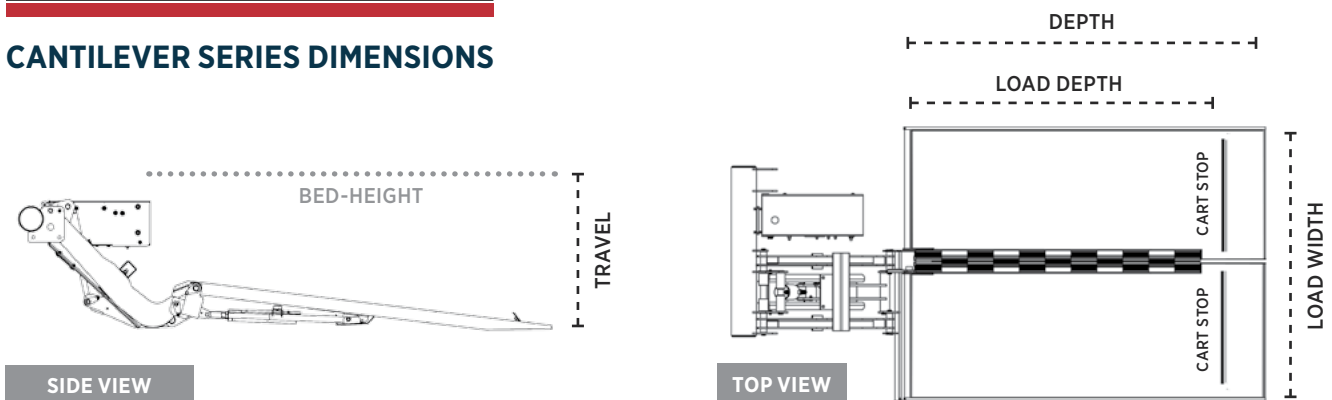

**CARGO VAN**

↑ **650** LBS CAPACITY

**650 SERIES**

**THE INTERNAL VAN LIFT**

Low-capacity, compact, and internally-mounted, the 650 Series is the ideal liftgate for lightweight van applications. 650 Series models fold up and store out of the way of ordinary tasks or flat against the inside of the rear door.

Fold-away interior mount offers two secure storage positions and easy access to the rear of the van.



**AVAILABLE MODELS**

ONE-YEAR STANDARD WARRANTY

	Model Number	Load Area	Taper	Travel	Applications <sup>1</sup>	Gate Weight
<b>650 lb. Capacity</b>	Smooth Steel Platform <b>650</b>	30 x 39	4	31.5	A, B, C	345

**STANDARD FEATURES**

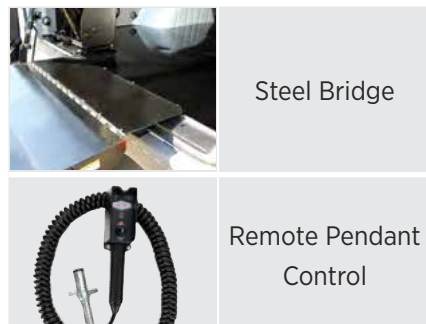

**650 SERIES DIMENSIONS**

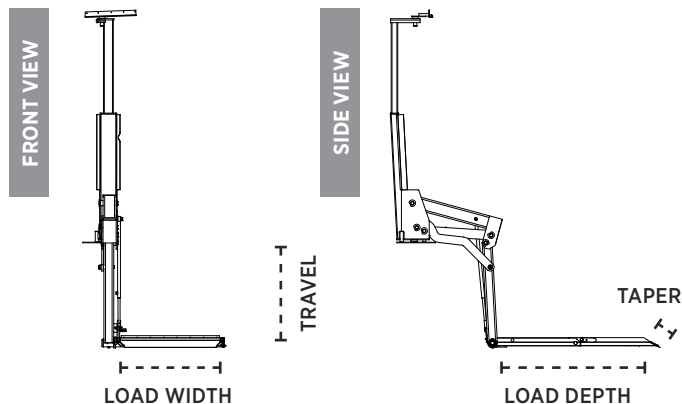

1. See applications on opposite page.
2. For detailed dimensions, visit [www.tommygate.com](http://www.tommygate.com)

# APPLICATIONS & BRACKETS

## FULL-SIZE PICKUP LIFTGATES

Code	Manufacturer	Model Year	Body Style	Bracket, Painted	Bracket, Galvanized
A	Chevrolet / GMC	2007-2016	1500	T-170	G-170
B	Chevrolet / GMC	2007-2016	2500	T-170	G-170
B	Chevrolet / GMC	2007-2016	3500	T-170	G-170
A	Chevrolet / GMC	2007	1500 Classic	T-160	G-160
B	Chevrolet / GMC	2007	2500 Classic	T-160	G-160
B	Chevrolet / GMC	2007	3500 Classic	T-160	G-160
A	Chevrolet / GMC	2002-2006	1500	T-160	G-160
B	Chevrolet / GMC	2002-2006	2500	T-160	G-160
B	Chevrolet / GMC	2002-2006	3500	T-160	G-160
A	Dodge / Ram	2002-2016	1500	T-330	G-330
B	Dodge / Ram	2003-2016	2500	T-330	G-330
B	Dodge / Ram	2003-2016	3500 (does not include 2013-2014 DRW)	T-330	G-330
B	Dodge / Ram	2013-2016	3500 (Dual Rear Wheel models only)	T-340	G-340
A	Ford	2002-2016	F-150 <sup>2</sup>	T-250	G-250
B	Ford	2002-2016	F-250	T-260	G-260
B	Ford	2002-2016	F-350	T-260	G-260
A	Nissan	2004-2016	TITAN <sup>® 3</sup>	T-420	G-420
A	Toyota	2007-2016	TUNDRA <sup>®</sup>	T-500	G-500

## CARGO VAN - 650 SERIES LIFTGATES

Code	Manufacturer	Model Year	Body Style	Bracket
C	Dodge / Ram	2014 - 2016	Promaster (High-roof)	13498
C	Dodge / Ram	2014 - 2016	Promaster (Standard Roof)	13080
C	Dodge / Ram	2015 - 2016	Promaster City	14502
A	Dodge / Ram	2002 - 2003	B-Series - Standard Body	2417
A	Dodge / Ram	2002 - 2003	B-Series - Extended Body	2417
A	Ford	2002 - 2014	E-Series	2408
C	Ford	2010 - 2013	TRANSIT CONNECT	10179
C	Ford	2014 - 2016	TRANSIT CONNECT <sup>3</sup>	13694
C	Ford	2015 - 2016	TRANSIT (high-roof)	13914
C	Ford	2015 - 2016	TRANSIT (medium roof)	14012
C	Ford	2015 - 2016	TRANSIT (low-roof)	13821
B	SPRINTER	2002 - 2006	Standard Roof	2397
B	SPRINTER	2002 - 2006	High Roof	2398
D	SPRINTER	2007 - 2016	Standard Roof	2632
D	SPRINTER	2007 - 2016	High Roof	2633
C	Nissan	2013 - 2016	NV200	13319
E	Chevrolet / GMC	2002 - 2005	ASTRO / SAFARI	2400
E	Chevrolet / GMC	2002 - 2016	EXPRESS / SAVANA	2410
E	Chevrolet / GMC	2015 - 2016	City Express	13319

## COMPACT PICKUP LIFTGATES

Tommy Gate Original Series liftgates fit many compact pickup trucks, not shown above. Visit [www.tommygate.com](http://www.tommygate.com) to learn more about model "MINI" liftgates.

1. Last 14 model years shown. For additional applications, visit [www.tommygate.com](http://www.tommygate.com)
2. 2002-2003 SUPERCREW<sup>®</sup> requires special Model 48 and T-105 bracket. Not compatible with G2 Series.
3. Requires special liftgate. Specify when ordering.
4. 650 can not store against inside wheel well on this application.

# TOMMY GATE







## **TOMMY GATE: YESTERDAY AND TODAY**

Woodbine Manufacturing Company was founded in 1965, in Woodbine, Iowa by Delbert “Bus” Brown. Working alone, Bus designed and constructed the original Tommy Lift, which he named after his son.

Early stories often recount Bus loading his pickup trailer with up to five liftgates at a time and driving off into the neighboring counties (where he would sell and install them himself), only to return once that trailer was empty.

This was Woodbine Manufacturing Company in its earliest days: a grassroots liftgate manufacturer that was created to ease the work of the local farmers.

Today, the Woodbine factory stands at over 200,000 square feet on the same piece of ground where every Tommy Gate liftgate has been manufactured and assembled for over 50 years. It is a state-of-the-art manufacturing plant that embraces a combination of modern technology fused with old-fashioned, hands-on welding and tooling.

Very much alive and well in the twenty-first century, Tommy Gate liftgates are sold by over 1000 distributors in every corner of the world.

Woodbine Manufacturing Company is one-hundred percent family-owned and operated, and has been since its inception. The company takes great pride in the work ethic, history, and traditions of its employees and strives to continue providing jobs and opportunities to the community it calls home.

It is a testament to the spirit of American manufacturing that Tommy Gate began with a single man, in a small, brick machine shop in rural Iowa.

---

## IMPORTANT NOTES

- Trademarks are property of their respective owners.
- Installation may affect specific vehicle features such as rear sensors, back-up cameras, and trailer hitches.
- All measurements in inches and pounds, unless otherwise specified.
- “Gate Weight” equals the approximate installed liftgate weight.
- “Load Area” is the liftgate platform’s flat, loadable area and is given as width x depth.
- Detailed liftgate dimensions are available at [www.tommygate.com](http://www.tommygate.com).

---

## LEGAL

**SPECIFICATION CHANGES** Woodbine Manufacturing Company, Inc. reserves the right to make changes in manufacturing to comply with current or new engineering specification changes where applicable.

**INSTALLATION COMPLIANCE & PROCEDURES** Before installing any liftgate, please observe the Vehicle Loading Limitations. These loading limitations are outlined in the Vehicle Owner’s Manual and the Safety Compliance Certification Label located on the driver’s door pillar.

Liftgate installers are to treat vehicles as incomplete and are therefore responsible for vehicle compliance with all local, state, and federal regulations, including but not limited to all lighting Regulations (see FMVSS 108) and all rearview visibility requirements (see FMVSS 111). Installers must also follow the procedures and specifications as detailed in Tommy Gate installation instructions, including ensuring the proper placement of all warning decals.

In view of the responsibility of altered-stage vehicle manufacturers to comply with FMVSS 111, Tommy Gate offers its “Camera and Sensor Bar” as a possible solution. However, it is the sole responsibility of the upfitter/final stage manufacturer to determine if the Tommy Gate Camera and Sensor Bar meets FMVSS 111 and/or any other applicable vehicle certification - and it is not the responsibility of Tommy Gate/Woodbine. Any information made available by Tommy Gate regarding its Camera and Sensor Bar is not intended to be, and shall not be, relied upon as a final determination of compliance with FMVSS 111 and/or any other vehicle certification. Each distributor must, on its own, make each such required determination for each vehicle it offers to a customer.

**WARNING** Tommy Gate liftgates are industrial products FOR MATERIAL HANDLING ONLY and are not to be used as a personnel or wheelchair lift. For safe handling and operating instructions, visit [www.tommygate.com](http://www.tommygate.com)

**TOMMY GATE LIFTGATE STANDARD WARRANTY** Tommy Gate G2 Series, Tuckunder Series, High-Cycle Railgates Series, and Cantilever Series liftgates have a two (2) year limited warranty from the date of user purchase against faulty material and workmanship. Tommy Gate Original Series, 650 Series, and standard Railgate Series liftgates have a one (1) year limited warranty from date of purchase. Pump and motor units have a two (2) year limited warranty. Normal usage requirements apply. All affected parts must be returned to the factory prepaid, with full credit issued for those found to be defective. Warranty replacement parts will be shipped from the factory prepaid. THERE ARE NO WARRANTIES, EXPRESS OR IMPLIED, INCLUDING THE WARRANTY OF MERCHANTABILITY OR A WARRANTY OF FITNESS FOR A PARTICULAR PURPOSE, EXTENDING BEYOND THAT SET FOR THE ABOVE.

**WARRANTY LIMITATIONS, LIMITATIONS ON WOODBINE’S LIABILITY AND INDEMNIFICATION** The modification of any Tommy Gate product in any manner not approved by Woodbine Manufacturing Company, Inc. immediately voids all warranties. Woodbine Manufacturing Company, Inc. shall not be held responsible for any damage resulting from the use of a modified Tommy Gate product, or one that was not properly maintained. The maximum liability of Woodbine Manufacturing Company, Inc. resulting from anything it did or did not do with respect to a Tommy Gate product shall be the price paid for that Tommy Gate product. Woodbine Manufacturing Company, Inc. will not be responsible for any loss of profits, goodwill, business opportunity or consequential damages. Recipients accepting shipments of any Tommy Gate product agree to indemnify, defend, protect, and hold Woodbine Manufacturing Company, Inc. harmless from and against any and all losses, damages claims or expenses of whatever form or nature, including attorneys’ fees and other costs of defense that Woodbine Manufacturing Company, Inc. may incur in connection with any acts or omissions related to the use or misuse of a Tommy Gate product and/or the unauthorized modification of a Tommy Gate Product.



**TOMMY GATE®**



**WOODBINE MANUFACTURING COMPANY, INC.**

83 Bus Brown Drive  
Woodbine, Iowa 51579  
[www.tommygate.com](http://www.tommygate.com)

TOLL FREE (800) LIFTGATE  
MAIN (712) 847-8000  
FAX (712) 647-2417