



ADRIAN STEEL®

Cargo Management Solutions for Commercial Vehicles

CARGO VAN EQUIPMENT for CHEVROLET EXPRESS & GMC SAVANA



2014 GM BUSINESS CHOICE PROGRAM



MAKE YOUR **CARGO VAN** WORK READY!

\$1200 UPFIT CASH*

Get the ultimate in flexibility when you take \$1200 and apply it towards any Adrian Steel upfit.

Anything in this catalog is eligible, including the new Commercial Curb Appeal graphics program!

Create a work ready van with exactly the trade specific equipment you need to do the job.

WHAT IS GM BUSINESS CHOICE?

GM Business Choice is an incentive program designed specifically for business owners who use vehicles in the day-to-day operation of their business and not solely for transportation purposes. This incentive is available when you purchase or lease an eligible Chevrolet or GMC cargo van.

SAVE TIME!

Don't go searching around town for product you need for your GM Cargo Van. Adrian Steel has a comprehensive line of cargo management solutions to get your van upfitted for your trade! You can leave the dealership with a cargo van that is ready to go to work!

COMMERCIAL EXPERTS!

Your GM Dealership and Adrian Steel Distributor can guide you through the upfit process. Utilize their product expertise to get a complete, turn-key work vehicle.

PRODUCT FLEXIBILITY!

Create a work ready van, designed by you, for your specific cargo carrying needs! Organize the interior of your van to suit your trade with Adrian Steel's modular product line. Start with the essentials: a partition, shelving and a roof rack. Then get trade specific by adding drawer units, door kits, hook bars, floor drawers and more!

PROGRAM TIMEFRAME & DETAILS*

The 2014 GM Business Choice Program runs through September 30, 2014. You must purchase or lease your vehicle and take delivery during the program time frame and provide proof of your business. Program is not available in all areas and may not be compatible with other offers or incentive programs. Consult your dealer for complete program details. For more information, please contact your local Adrian Steel Distributor.

*US program only. See website for GM Canada program details.

GM is a registered trademark of the General Motors Corporation.

PLAN YOUR WORK READY VAN



TIME IS MONEY! GET ON THE ROAD WITH EVERYTHING YOU NEED TO GET BACK TO BUSINESS.

Adrian Steel has all the storage products you will need, and the distributor network to professionally install your interior and graphics to get you back serving your customers faster. Below is a guide to help you set up your work van with the equipment you need to get the job done. Build your own interior with our modular products, or start with a Work Ready Van Package (pages 29-40) and modify it to your specific needs. Then, utilizing the Commercial Curb Appeal design tool, create a custom van graphic to complete your work van upfit.

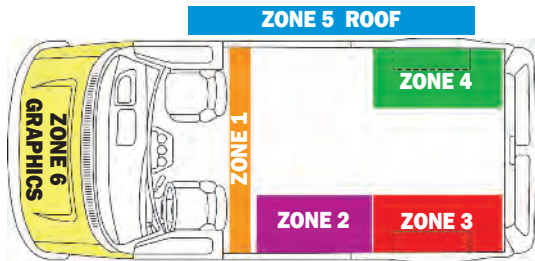

ADDITIONAL STORAGE

- Determine the space needed for specialty equipment.
- Add accessories to shelving and partition
- Hooks, drawers, files, screens, and more.
- See available accessories on pages 18-21.
- **I need:**

ZONE 1 PARTITION

- Choose partition style: solid or perforated. Do you want a hinged door? See page 6.
- Choose the standard or 3" setback wing kit and add accessories.
- **I need:**

ZONES 2, 3, 4 CURBSIDE & STREETSIDE

- Use layout diagrams to determine the amount of space available.
- Choose from a variety of shelving units and modules that will best organize the tools and equipment you need to carry.
- Or, choose a Work Ready Upfit, complete with a trade specific, pre-designed interior and custom graphics package.
- **I need:**

ZONE 5 ROOF

- What do you need to carry?
- Choose from LoadsRite, Grip-Lock, Utility and Cargo racks.
- Add rack accessories including step ladder kits, ratchet straps, conduit carriers and more.
- **I need:**

ZONE 6 VEHICLE GRAPHICS

- Stand out in the crowd!
- Vehicle graphics are the most cost effective form of advertising!
- Go to www.commercialcurbappeal.com and start designing!



GM LONG WHEELBASE VAN 1996-ON

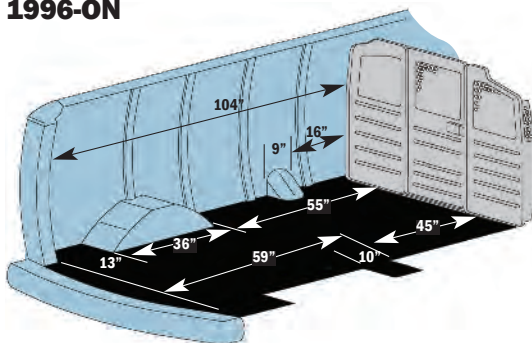

GM EXTENDED LONG WHEELBASE VAN 1996-ON

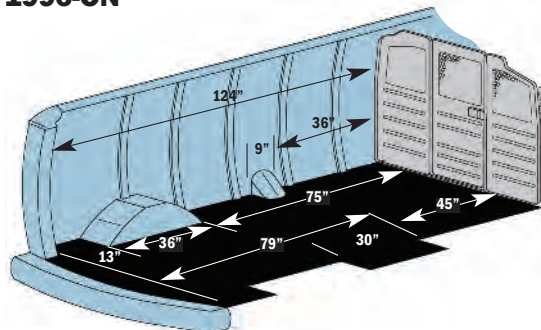

Note: Dimensions for reference only. Measure your van or contact your distributor for your exact needs.

Need some help? Contact your local distributor! They can provide a wealth of information about utilizing the cargo space in your work van. Find your local distributor online at adriansteel.com.

INDEX

- 3 Plan Your Work Ready Van
- 4-5 Commercial Curb Appeal
- 6-7 Partitions & Accessories
- 8-11 Shelving
- 14-17 Storage Modules
- 18 Storage & Data Files

- 19 Floor Drawers
- 20-21 Van Accessories
- 22-28 Roof Racks & Accessories
- 29-39 Work Ready Upfits
- 40 Liner Kits
- 41-43 Index

All illustrations, photos and specifications in this publication are based on the latest product information available at the time of content approval.

The right is reserved to make changes at any time, without notice, in materials, specifications and models, and also to discontinue models.



MOBILIZE YOUR BRAND WITH ADRIAN STEEL'S VEHICLE GRAPHICS PROGRAM.

Adrian Steel and Signature Graphics have partnered to be able to provide you with a complete, work ready van. Go on-line to create the look you want, then have your graphics and interior package installed all at the same time at your local Adrian Steel distributor. This saves time and gets your new van in service and working for you quicker.

NEW VAN, NEW LOOK

The key to commercial graphics is setting yourself apart from the competition. Effective use of color, direct messaging and simple brand identification turn your vehicle into a viable advertising tool.

WHEN CONSIDERING YOUR DESIGN, START WITH THE BASICS:

- Name and logo**
- Phone number and website**
- Services you offer**
- Your essential message**
- Pictures of your product**



BRANDING

More than just your logo, your brand is the total package presented at every point of public contact.

Brands can provide customers with instant and powerful recognition of your business and the services or products that you offer. When you take your brand to the streets, you make an impression on every person you pass.

Completely redesign or just upgrade your image as part of your brand strategy to help grow your business. When it comes to graphics, sometimes less can mean more. While full wraps are an attractive option that we offer, a budget conscious small business owner can have a significant impact on their image without covering the entire vehicle.

IT'S EASY!

Step 1

User logs in and selects vehicle year, make, model, and options. The site is preloaded with most commercial vans and pickups.

Step 2

A blank vehicle will appear on the screen and you are ready to begin designing. The design tool allows users to personalize a professionally designed template, or create a new design from scratch.



Step 3

Once you have finished your new vehicle design you can instantly price the production and installation by clicking the estimate button. Print your quote to share with your local dealer at the time of your vehicle purchase and include the cost in your financing. Within 7-10 days, your vehicle will be ready to roll!

Start Now at www.commercialcurbappeal.com!

TO WRAP OR NOT TO WRAP?

Take a look at these examples designed and priced on CommercialCurbAppeal.com

\$1800

Simple design on the side.
Logo on hood or rear door.

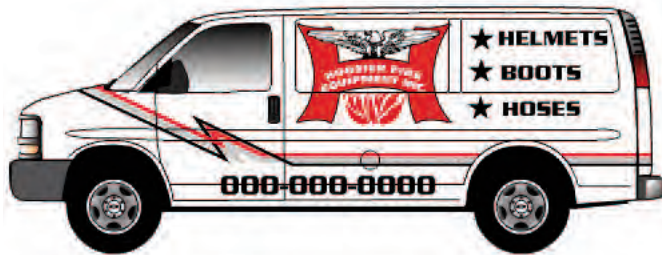

\$2200

More complex design on the side.
Logo on hood and/or rear door.

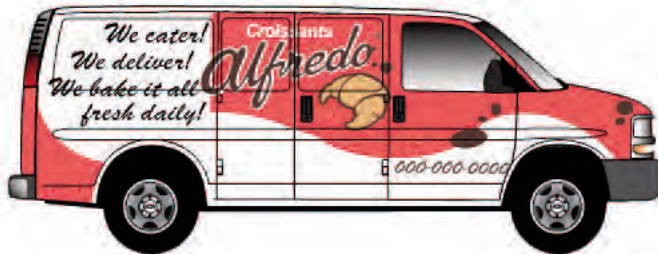

\$4000

A full wrap with a complex design covering all possible areas.

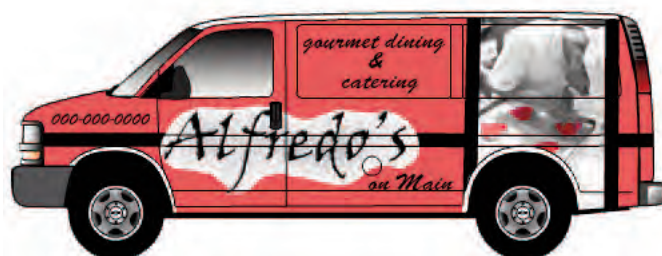

VINYL 101

CommercialCurbAppeal.com produces your graphics on commercial grade vinyls that are the benchmark of the fleet industry. Fit, finish, durability and removability are all critical when considering your investment so they look as good on day 1 as day 1000.

DIRECTV, Best Buy, TRANE, Geek Squad and Penske are all produced with the exact same films. Rest assured that the 3/36 warranty through your Adrian Steel Distributor includes the graphics.

Installation is made simple through your dealer or Adrian Steel distributor.

NEED MORE REASONS WHY?

CommercialCurbAppeal.com allows you to personalize your vehicle and be sure it positively represents your business.

By adding graphics to the upfitting process your vehicle will be in service faster, saving you time and money.

Graphics through CCA can often be added to your financing package, amortizing your new look over the life of your vehicle.

Graphics will help increase your vehicle visibility and build brand awareness in the community.

Comparatively, vehicle graphics are more affordable than most other advertising options.

BEING NOTICED IS EVERYTHING!

www.commercialcurbappeal.com

*Commercial Curb Appeal not available in Canada.

 **ADRIAN STEEL**

800.677.2726

PARTITIONS

ADRIAN STEEL PARTITIONS KEEP CARGO WHERE IT BELONGS, IN THE CARGO AREA!

All hinged door partitions come standard with two 6" hinges, bulb seal and a slam latch. These features reduce vibration noise. Partitions are sold as panel kits and wing kits. Please see application chart below to confirm the appropriate panel kit and wing kit for your vehicle. Partition panel kits and wing kits include assembly and installation fasteners for base van trim level. Higher trim levels may require modifying trim or partition. Wing kits are available in a standard position or an extended position for more leg room.

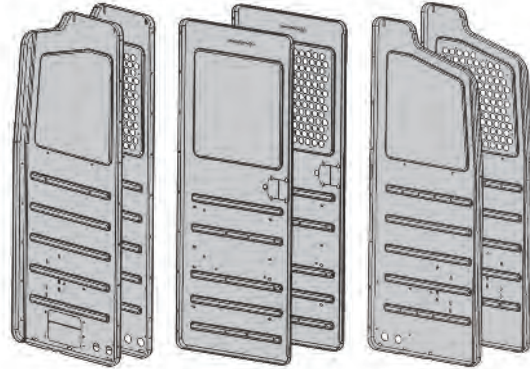

S1 Solid
S2 Perforated Top
Panels mount behind driver seat.

M1 Solid
M2 Perforated Top
Fixed center panels can be hinged as key-locking doors

C1 Solid
C2 Perforated top
Panels mount behind passenger seat.

S-M-C SERIES PARTITIONS

Choose from solid or perforated top panels made from 18-gauge steel for strength and finished in a tough Steel-Cote powder coat paint. S-M-C Series partitions fit GM full size vans. Center M panels can be fixed or hinged with a key-locking door. Partitions are sold as panel kits and wing kits. Please see application chart to confirm the appropriate panel kit and wing kit for your vehicle. Partition panel kits and wing kits include assembly and installation fasteners for base van trim level. Higher trim levels may require modifying trim or partition.

Note: Extended wing kits reduce the amount of cargo space. Please confirm the interior layout of the van package to confirm that the extended wing kit has adequate room needed for installation. 3" extended wings not compatible with GM Pro/Access vans.

Panel Kit Part Number	GM FSV
Fixed Center Panel	Wing Kit
SOLID PANELS	WKC1FSVGM
S1M1C1FSV	WKC1FSVGM3
CENTER PANEL PERF. TOP ONLY	WKC1FSVGM
S1M2C1FSV	WKC1FSVGM3
PERF. CENTER & CURB PANELS	WKC2FSVGM
S1M2C2FSV	WKC2FSVGM3
ALL PANELS PERFORATED	WKC2FSVGM
S2M2C2FSV	WKC2FSVGM3
X1 STYLE	WKX1FSVGM
X1FSV	WKX1FSVGM3
PS1 STYLE	WKPS1GM
PS1FSV	WKPS1GM3
Hinged Center Panel "Door"	GM
SOLID PANELS	WKC1FSVGM
S1M1HC1FSV	WKC1FSVGM3
CENTER PANEL PERF. TOP ONLY	WKC1FSVGM
S1M2HC1FSV	WKC1FSVGM3
PERF. CENTER & CURB PANELS	WKC2FSVGM
S1M2HC2FSV	WKC2FSVGM3
ALL THREE PANELS PERFORATED	WKC2FSVGM
S2M2HC2FSV	WKC2FSVGM3



X SERIES PARTITION

Get maximum side and rear view mirror visibility with X Series partitions. X Series partitions are designed with a large perforated upper panel, eliminating obstructions to driver side and rear views. Made from 16-gauge steel and finished with our Steel-Cote powder coat paint.

X1FSV - X Series Partition for Full Size Vans

POLYSTEEL PARTITIONS

Provide full rear and side cargo door visibility. Constructed from 16 gauge steel for strength, Polysteel combines a polycarbonate center panel for uninterrupted driver visibility. Full-size vans feature an 18" x 34" center panel, angled to reduce reflection and glare from oncoming headlights.

PS1FSV - Polysteel Partition Full Size Van



See more partition images and accessories on-line at adriansteel.com.

PARTITION ACCESSORIES



ADRIAN ACCESSORIES FULLY UTILIZE YOUR PARTITION SPACE.



CB2 Two Book File has hinged retaining strap. Mounts to floor or other horizontal surface. **Overall size: 6" W, 14" H, 9 3/4" D.**

PA7 Triangle Reflector Kit comes with a metal pocket holder, I.C.C. approved.

PA10 Practice Holder is a partition-mounted holder for forms, manuals or work related papers. **Overall size: 12" W, 7" H, 5" D.**

PA8 1-A: 10-BC Fire Extinguisher is a rechargeable, 2-1/2 lb. dry chemical extinguisher. Stops Class A, B and C fires. Complete with charge gauge and mounting bracket.

PDK1 Door Kit converts M-Series fixed center panel into hinged door with keyed slam latch. Includes two 6" hinges, bulb seal and a slam latch. These features reduce vibration noise.

Plexiglas Partition Cover Panels (not shown)

PA5-1 fits S panel.

PA5-2 fits M panel.

PA5-3GMS fits X1 GM van partition. Includes two panels for center upper and curb wing.

PA5-6GMS fits C2 GM van panels and wing kit panel only.



WING EXTENSION KITS

Extend the amount of cab space by an additional 3 inches with Adrian Steel's extended partition wing kits.



TA1

TA1 Hook Bar maximizes vertical storage space. 2" x 12" bar mounts to partition or other vertical surfaces. Four hooks with 2" hanger opening.



PA11

File Management for Important Documents

PA11 Cab File Box mounts to partition or other vertical surface. **Overall size: 14" W, 10-1/2" H, 3-1/2" D.**



TH30

TH30 Refrigerant Tank Holder 30 lb.-holds tank to partition or other vertical surface.

TH50 Refrigerant Tank Holder 50 lb.-holds tank to partition or other vertical surface.



PA9

PA9 First Aid Box Tray secures first aid box to partition or other vertical surface.

Overall size: 11" W, 4-1/2" H, 3-1/8" D

ADSERIES ADJUSTABLE SHELVING

EXCLUSIVELY FROM ADRIAN STEEL: A SHELVING PLATFORM THAT ALLOWS YOU TO PUT SHELVES WHERE YOU WANT THEM, NOT WHERE WE THINK YOU NEED THEM!

ADseries is the next generation of cargo management solutions, engineered to optimize your work van storage and accessibility. Featuring truly ADjustable shelves, an ADaptable rail system, heavy-duty shelves and an ADvanced stamped steel end panel designed to accommodate the diverse range of cargo you need to get the job done. ADseries is ADrian made and backed by our industry-leading 3 year/36,000 mile warranty.



AD

series

For the Way You Work!

ADVANCED DESIGN

Stamped steel end panels and shelves, ADseries components are strong, durable and ready to work hard. 6" knock out provides a 48" floor space to accommodate 4'x 8' sheet goods (up to 22 sheets of 1/4" drywall or a combination of thicknesses).

Contoured end panels maximize aisle space by providing 36" in GM full size vans between the panels from the top to bottom.



**SEE THE
ADSERIES IN
ACTION!**

ADSERIES ADJUSTABLE SHELVING

ADJUSTABLE SHELVES

Tools, equipment and cargo come in all shapes and sizes and until now, there hasn't been a shelving unit that is truly adjustable. The ADseries is the first of it's kind where, with only a screwdriver, you can simply remove the front shelf bolts and move the shelf where you need it. Shelves can be adjusted in one inch increments and provide the most flexible shelving solution available.

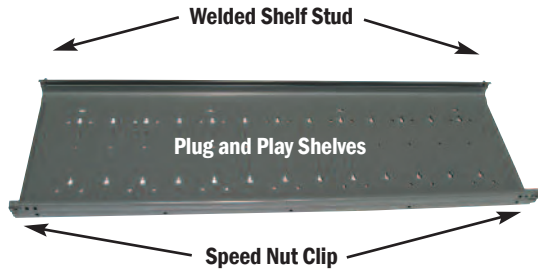

Truly Adjustable Shelves All you need is a phillips screwdriver! Simply remove two bolts from the speed nut clips that come with the shelf, tilt the shelf upwards, move the shelf to your desired location, insert the rear shelf studs, reattach the bolts and you're done!

Rear Shelf Studs unique design lock shelves in place!

ADAPTABLE INTERIOR

Everyone likes to set their work van up their own way. The new ADseries shelving lets you position the shelving where you need it. Exclusive to the ADseries, the unique rail system enables you to reposition the shelving in the van, increasing the available space for trade specific equipment. All of this is done without removing bolts, plugging holes and redrilling the van!

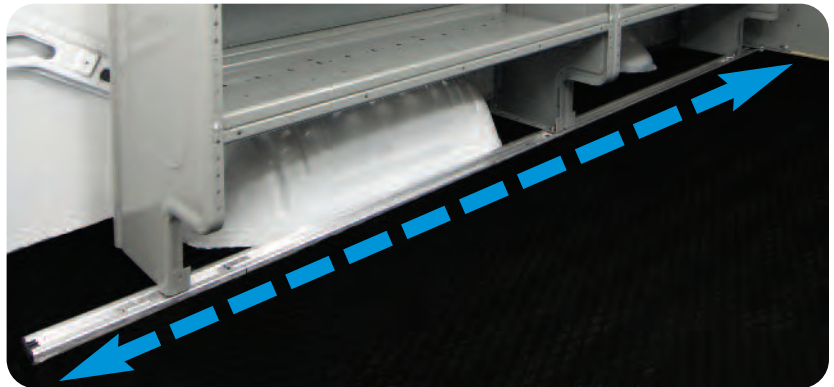

ADD ACCESSORIES

Businesses change over time and your van interior should be able to change with your needs. Plug and Play shelves have prepunched holes that allow adding storage solutions easily! ADseries dividers simply snap in place, drawer units simply bolt in and door kits can be added to lock your more valuable parts and equipment. Many Adrian Steel accessories can be added to the ADseries shelving with the rail adapter kits and end panel brackets.



ADseries Shelf Units and Rail Kits

Model	Size	Description
AD32FP	32"W x 46"H x 14"D	fits GM FSV
AD44FP	44"W x 46"H x 14"D	fits GM FSV
AD50FP	50"W x 46"H x 14"D	fits GM FSV

RKFSVLHD	Rail System	fits GM LHD
RKFSVLWB	Rail System	fits GM LWB
RKFSVXLWB	Rail System	fits GM XLWB

ADseries Accessories

Model	Size/Description
DV14C1	Divider for ADseries/Single
DV14C8	Divider for ADseries/8 Pack
DK3008	8" High Door Kit/AD32FP
DK3010	10" High Door Kit/AD32FP
DK4208	8" High Door Kit/AD44FP
DK4210	10" High Door Kit/AD44FP
DK4808	8" High Door Kit/AD50FP
DK4810	10" High Door Kit/AD50FP
BRK14EPS	End Panel Bracket To Add on Accessories
RKA1	Rail Kit Adapter/See list at right
RKA3	Rail Kit Adapter3/See list at right
RKA4	Rail Kit Adapter4/See list at right
RKABRK1	Rail Kit Adapter/End Panel Bracket/See list
RKABRK2	Rail Kit Adapter/17A
RKAWTR	Rail Kit Adapter/Welded Tank Racks
RKA919	Rail Kit Adapter/#9, #19, #919 Drawer Units
35325-G	32" Long Shelf
35327-G	44" Long Shelf
35328-G	50" Long Shelf

RKA1 – Rail Adapter Kit1
Use with: CB2, CB3, CB4 (uses 2)

RKA3 – Rail Adapter Kit3
Use with: #1, #1.2, #2, #8, DC Units, 17A, CRH2, TA19, TA5

RKA4 – Rail Adapter Kit4
Use with: 17A, CB5, 43, TA19, KDRH2, KD Shelving Units, #33, #3, #33W, JD Shelving

BRK14EPS – ADseries end panel accessory attachment bracket.
Use with: 17A, CB5, 43, TA19, TA20, WRH5, UH10/25/50, PA9, PA8, ACT3/4, PA11, AGSCH2, PA7, TH30, TH50, TA5

RKABRK1 – Used with TA19, TA20, TA5

Note: Rails are not included with the shelf units. Rail kits must be ordered separately

Note: Shelves have the following weight rating:

Shelves positioned with the shelf lips facing up have a rating of 100lbs per shelf evenly distributed.

Shelves positioned with the shelf lips facing down have a rating of 200lbs per shelf evenly distributed.

ADJUSTABLE SHELVING

CONFIGURE SHELF SPACING TO YOUR SPECIFIC CARGO MANAGEMENT NEEDS. Adrian Steel Adjustable Shelving is available in narrow, 10" units up through extra long, 60" units and are designed to best utilize the space within your van. Set shelf space to fit your particular needs. Shelf lips keep items from rolling off shelf while in transit. Locking Door Kits convert a shelf into an enclosed, locking cabinet.

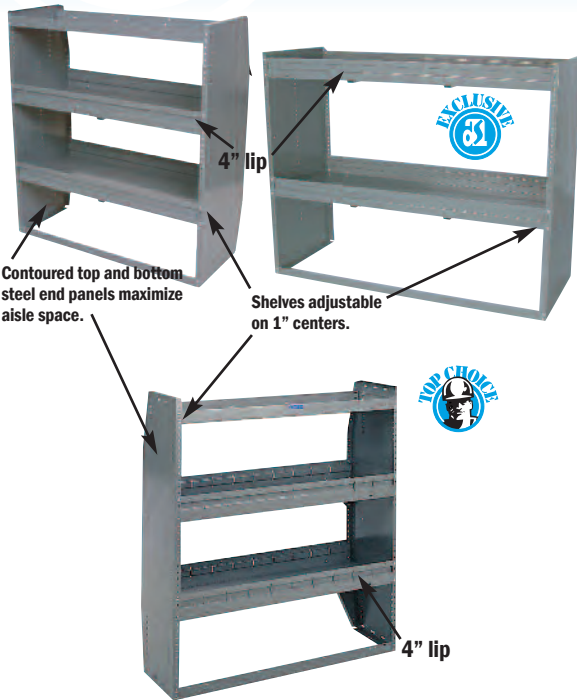

JD SERIES JUMBO DEEP SHELVING

Available in 18" and 24" depths. Shelf gussets and floor rail provide extra strength.

- 18" deep units contain one 14" and two 18" deep shelves.
- 24" deep units have squared end panels and two shelves. See chart.

Model	Overall Size	Open Shelf Space
JD42FP	42"W x 46"H x 18"D	14.58 sq ft
JD52FP	52"W x 46"H x 18"D	18.56 sq ft
JD48FP	48"W x 48"H x 24"D	20.21 sq ft
JD60FP	60"W x 48"H x 24"D	20 sq ft

HD SERIES HEAVY DUTY SHELVING

Features shelf gussets and full floor-rail that provide extra strength, and contoured end panels that maximize aisle space.

- Contains 12" deep top tray with 2" lip and two 14" deep shelves with 4" lip.

Model	Overall Size W H D	Door Position	Door Kit Model	Open Shelf Space
HD-32FP	32" x 46" x 14"	Shelf Floor	DK532* DK532A	8.89 sq ft
HD-42FP	42" x 46" x 14"	Shelf Floor	DK542* DK544	11.67 sq ft
HD-52FP	52" x 46" x 14"	Shelf Floor	DK552* DK552A	14.44 sq ft

* Back panel included with door kit

KD SHELVING

KD shelf racks feature shelves that are fully adjustable on 1" centers. #3 and #33 feature solid end and back panels and four adjustable shelves. The #33W and 33WB have welded, contoured end panels and contain two welded shelves and three adjustable shelves. The 33WB includes four removable plastic bins with dividers.

Model	Overall Size	Shelf Lip	Open Shelf Space
3	18"W x 46"H x 12"D	2"	6 sq ft
33	12"W x 46"H x 12"D	1"	4 sq ft
33W	10"W x 46"H x 14"D	1"	4.71 sq ft
33WB	10"W x 46"H x 14"D	1"	N/A

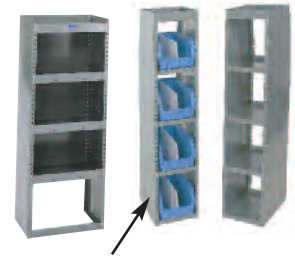

Contoured top and bottom steel end panels maximize aisle space.

30 SERIES SHELVING

30 Series shelving contains one 12" and two 14" deep shelves. Contoured end panels provide flush fit to van side. Four shelf gussets and full floor-rail for added strength. Shelves are adjustable on 1" centers and have 2" lip for containment. See chart.

Model	Overall Size	Position	Door Kit	Open Shelf Space
30-32	32"W x 36"H x 14"D	Shelf Floor	DK532 DK532A	8.89 sq ft
30-42	42"W x 36"H x 14"D	Shelf Floor	DK542 DK544	11.67 sq ft
30-52	52"W x 36"H x 14"D	Shelf Floor	DK552 DK552A	14.44 sq ft

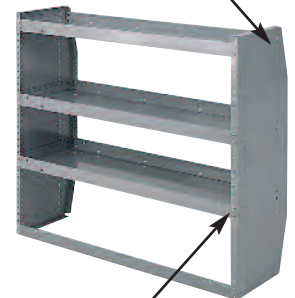

Shelves adjustable on 1" centers.

OPEN END ADJUSTABLE KD SHELVING

Open End Adjustable KD Shelving includes three shelves adjustable on 1" centers. The top tray has a 2" containment lip, other shelves have 1" lip. Open End shelving can be assembled in "A" (pictured left) or "B" style for mounting over wheelwells. It has a bracketed set back forth corner for improved wheelwell fit.

Model	Overall Size	Door Position	Door Kit Model	Open Shelf Space
MD520	18"W x 36"H x 12"D	N/A	N/A	4.50 sq ft
MD521	24"W x 36"H x 12"D	N/A	N/A	6 sq ft
MD521B	24"W x 36"H x 12"D	N/A	N/A	6 sq ft
MD522	30"W x 36"H x 12"D	Shelf Floor	DK530 DK530A	7.50 sq ft
MD522B	30"W x 36"H x 12"D	Shelf Floor	DK530 DK530A	7.50 sq ft
MD523	36"W x 36"H x 12"D	Shelf Floor	DK536 DK536A	9 sq ft
MD523B	36"W x 36"H x 12"D	Shelf Floor	DK536 DK536A	9 sq ft
MD524	42"W x 36"H x 12"D	Shelf Floor	DK546 DK546A	10.50 sq ft
MD524B	42"W x 36"H x 12"D	Shelf Floor	DK546 DK546A	10.50 sq ft



ADJUSTABLE SHELVING



SHELVES

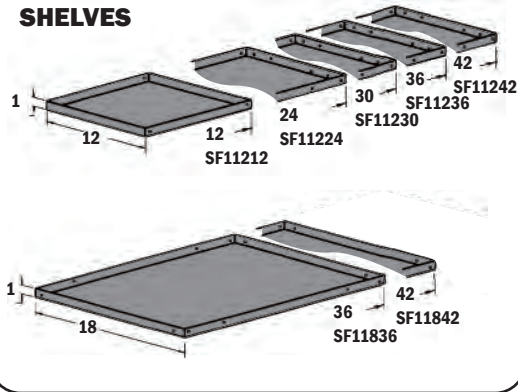

FLOOR RAILS

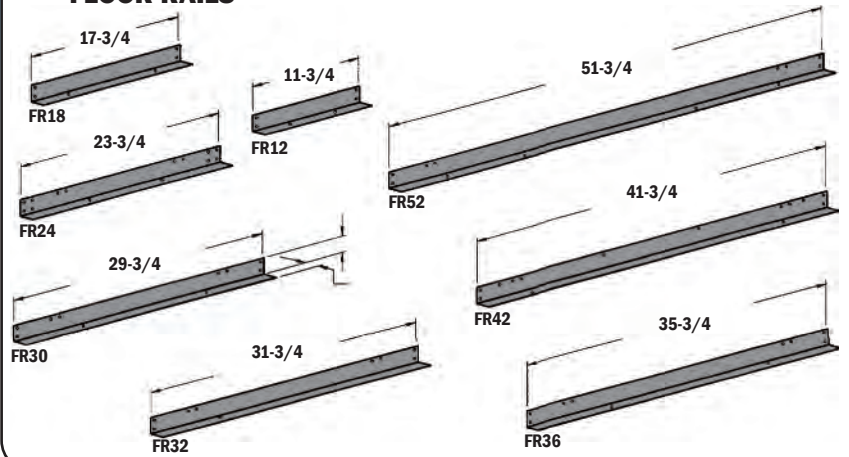

TOP TRAYS

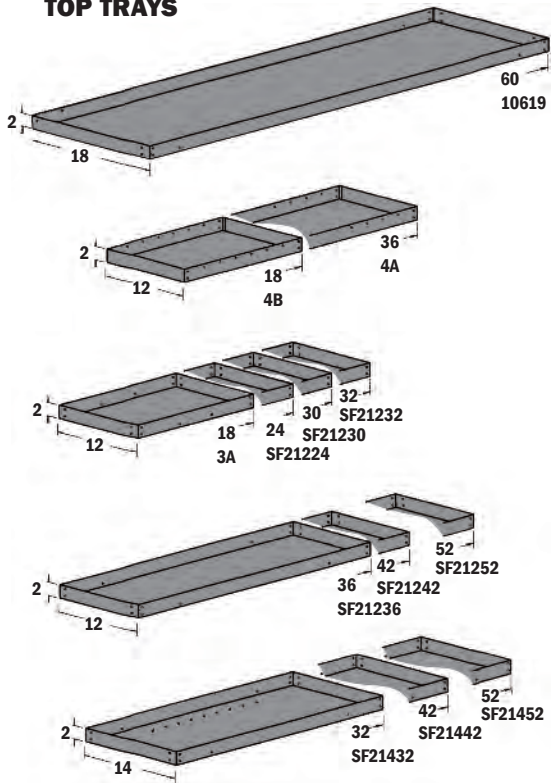

VERTICAL MEMBERS

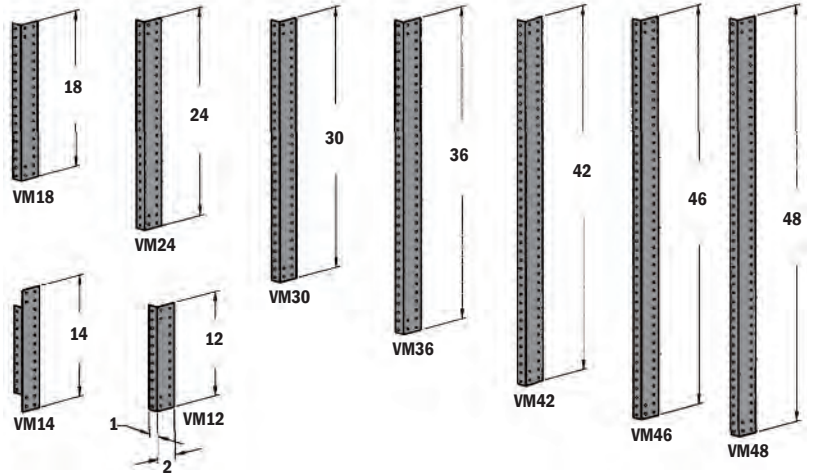

FLOOR ANGLES

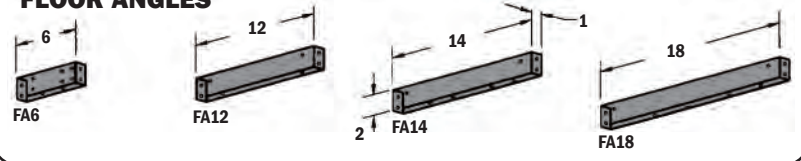

HD SHELVES

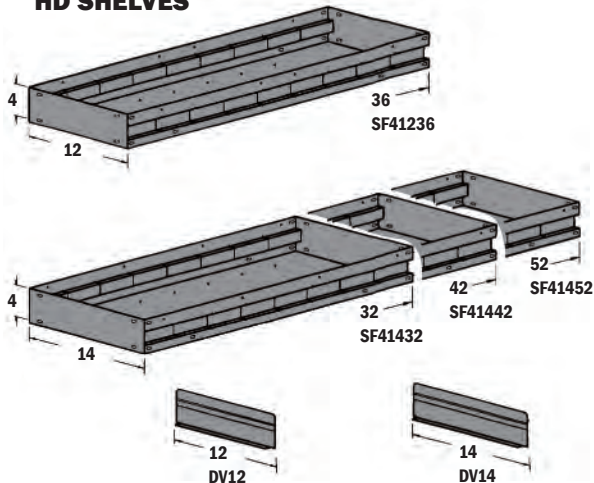

END PANELS

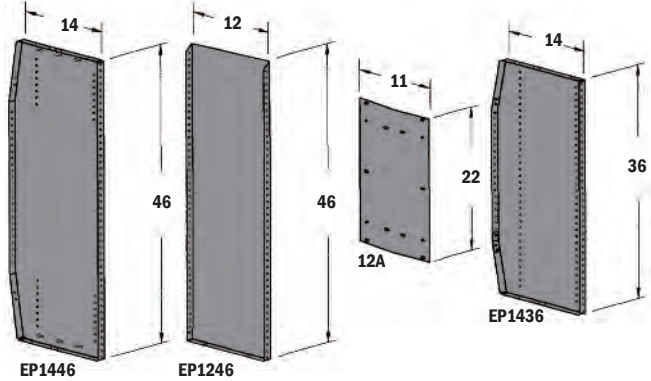

Note: All measurements are in inches.

WELDED SHELVING

ADRIAN'S 44 SERIES OF WELDED SHELVING IS SOLID, STRONG AND FUNCTIONAL.

The 44 Series features a top shelf that has been lowered to be more functional allowing you to divide the shelves or add our popular blue bins. The mid and lower shelves are more functional with the ability to add door kits, DC drawer units, Lock and Latch drawer units, dividers and blue bins. The best selling shelf unit just got better.

Features and Benefits

- All shelves welded to end panels – greater weight capacity and reduces cargo noise.
- Contoured end panels provide a flush fit to van wall and maximizes aisle space.
- Welded back panel for containment and reinforcement.
- Shelving can be installed in any position within the van.
- All shelving is finished with Steel Cote™ – a powder coat, diamond-hard finish that resists scratching and chipping better than standard paint finishes.
- Now three sizes available – 32", 42" and 50" wide models.

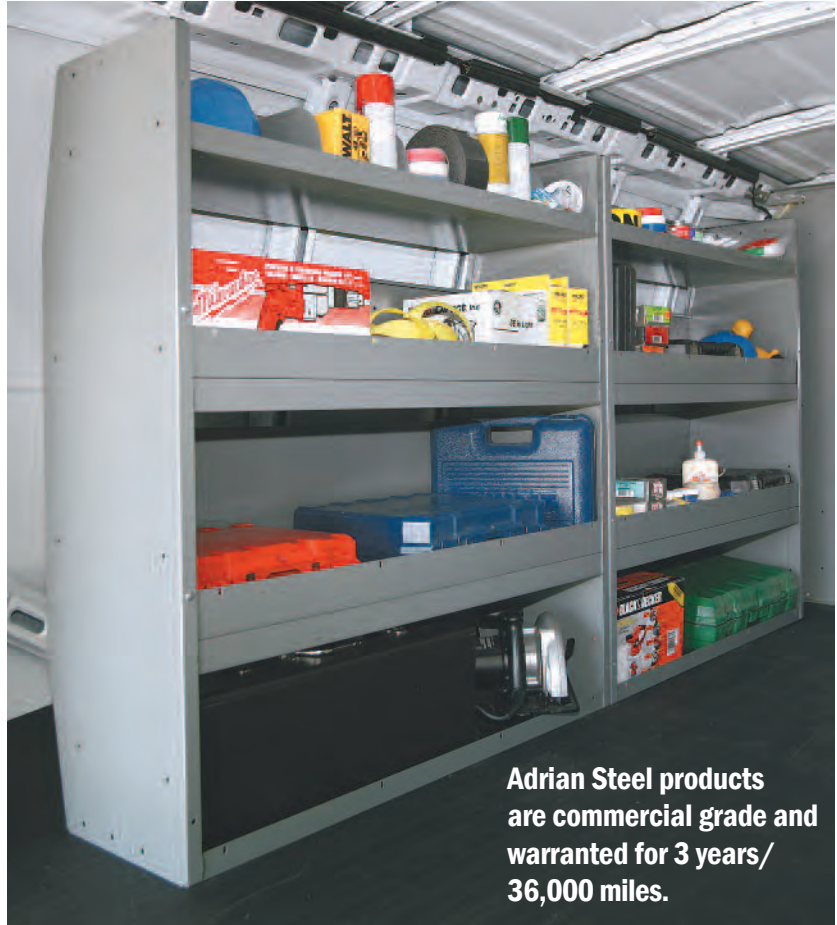

Adrian Steel products are commercial grade and warranted for 3 years/36,000 miles.

HEAVY DUTY UTILITY SHELVES

- Constructed from heavier gauge steel.
- Welded dividers maximize carrying capacity.
- Divided top tray is 3" deep for increased rigidity.



No. 18 Heavy Duty Utility Shelf
Measures 36"W x 22"H x 12"D



WELDED SHELVING

NOW AVAILABLE IN 32", 42" & 50" LENGTHS

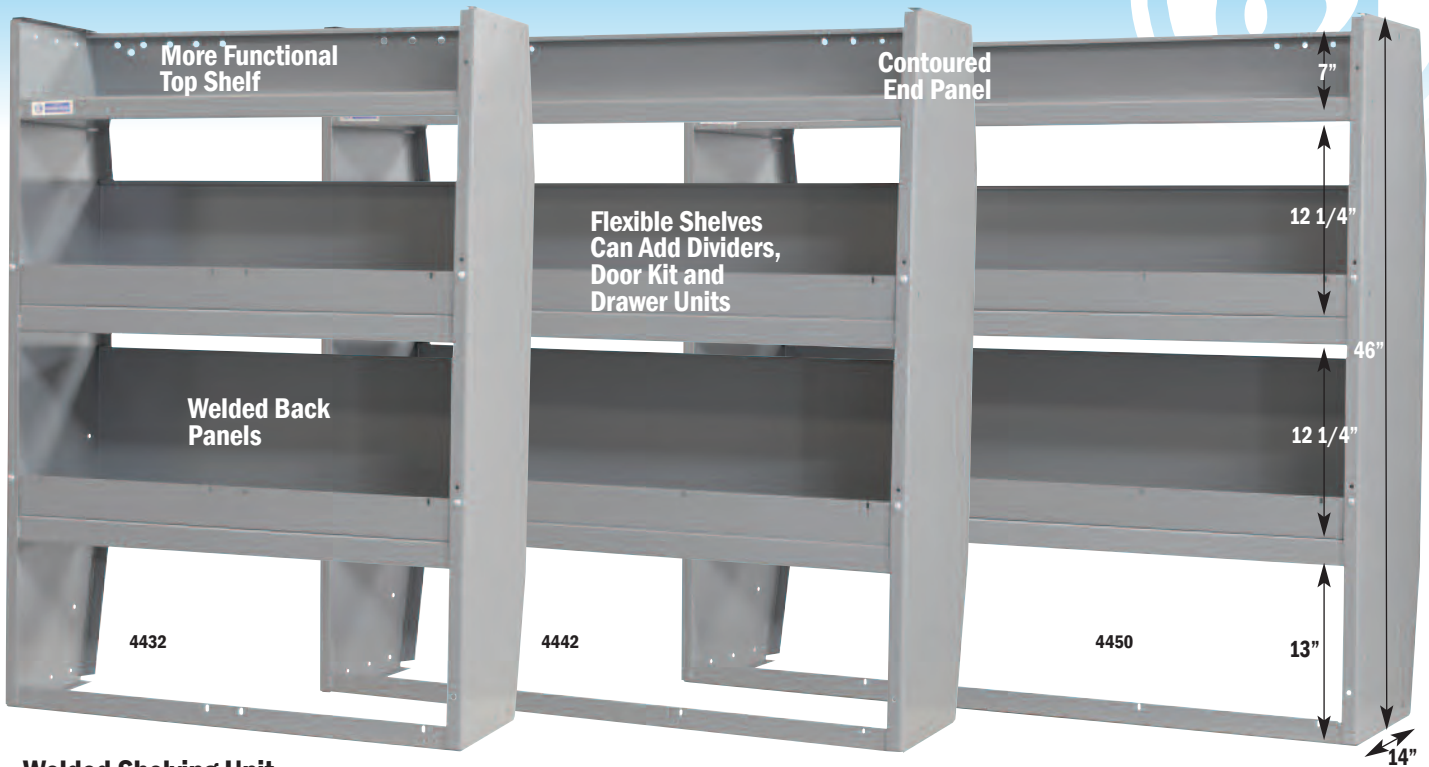
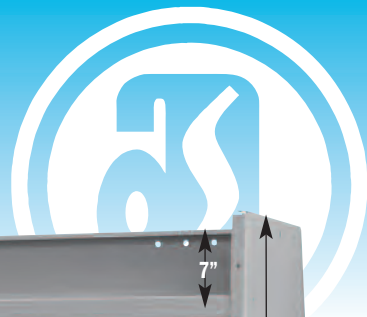

Welded Shelving Unit

Model	Description
4432	Welded Cabinet - 32"W x 46"H x 14"D
4442	Welded Cabinet - 42"W x 46"H x 14"D
4450	Welded Cabinet - 50"W x 46"H x 14"D



Contoured top and bottom steel end panels maximize aisle space.

ACCESSORIES FOR WELDED SHELVING

Upgrade the 44 Series with Dividers, DC Drawer Units, Lock & Latch drawer units, Door Kits and our popular #28 Blue Bins!



Plug & Play units - add accessories in minutes!



Drawer Component Shelves

- Create customized shelving modules with drawer component shelves.
- Built to bolt onto the DC6 and DC12, these shelves can provide additional storage space.
- The shelves are available in 18", 24" and 36" wide configurations.
- Feature a 1" shelf lip.

Model	Description	Shelf Size
SF11218DC	18" wide DC Shelf	12"D x 18"W
SF11224DC	24" wide DC Shelf	12"D x 24"W
SF11236DC	36" wide DC Shelf	12"D x 36"W

Accessories

Model	Description
DV44U1	Top shelf divider (single)
DV44U4	Top shelf divider kit (4 pack)
DV44U	Top shelf divider kit (8 pack)
DV44L1	Lower shelf divider (single)
DV44L4	Lower shelf divider (4 pack)
DK532	Door kit for 44 series shelving, 4432
DK544	Door kit for 44 series shelving, 4442
DK550	Door kit for 44 series shelving, 4450
28	Plastic Blue Bin

CABINET MODULES

SPECIFIC JOBS DEMAND SPECIFIC STORAGE SOLUTIONS.

Cabinet and Drawer Modules provide secure storage for large and small tools and parts. The modular design allows you to get what you need now and the ability to add more when you need it. Whatever the job demands, Adrian has the storage solutions to transport your gear safely and securely.



Tank Cabinets

- Provide vented storage for Propane, Mapp gas or CO2 tanks.
- Cabinets feature a full door gasket with two snap latches for positive door closure.
- Interior cabinet cradle and retaining straps (foam yokes for TA19) secure tanks and prevent movement.
- Floor vent and tubing are included for exhausting fumes.
- Propane cabinets store 20, 30 or 40 lb. tanks.
- Mapp Gas Cabinets store 6 1/2" diameter tanks.
- CO2 Tank Cabinets store 20 lb. cylinders.

Model	Description	Cabinet Size
TA18	Propane Cabinet	14-3/4"W x 36"H x 13"D
TA19	CO2 Tank Cabinet	13"W x 32"H x 12-1/2"D
TA20	Mapp Gas Cabinet	14"W x 26"H x 8"D

Vented gas storage solutions



Shelf Cabinets

- Available in 12" and 18" front to rear lengths
- Can be used free standing or stacked with our lockable drawer units.
- Feature locking recessed tee-handles for secure storage and receive a durable gray powder coat finish.
- Cabinets feature an open side and can be combined for side-by-side use holding items up to 35" long.
- Optional end panel can be added to close off side when required.
- Include an adjustable shelf that can be removed
- Cabinets provide a solid surface to stack modular drawers, cabinets and bins.

Model	Description	Cabinet Size
1	Shelf Cabinet	18"W x 22"H x 18"L
12	Shelf Cabinet Open Side	18"W x 22"H x 12"L
1A	Optional Shelf	No. 1
12A	Optional End Panel	No.12

Folding T handles don't stick out into aisles.



Wheel Well Cabinets

- Wheel well cover cabinets are designed with an open back and bottom.
- Serves as an enclosure for rear wheel wells.
- Provides a solid surface to stack modular drawers, cabinets and bins.
- Cabinets come with locking recessed tee-handles for secure storage.
- Finished with a durable gray powder coat finish.

Model	Description	Cabinet Size
40	Wheel Well Cover Cabinet	42"W x 12-1/2"H x 14"L



Cabinet Lockers

- Full-door Lockers feature a 46" high storage space with 3 removable shelves.
- Short-door Lockers feature a 33" high storage area and with 2 removable shelves.
- Locker doors are reversible for flexibility and feature locked recessed T-handles for security.
- Cabinet Lockers taper from 14" to 12" from front to back in depth at top and bottom to maximize aisle space.

Model	Description	Cabinet Size
CL1446R	Cabinet Locker Full Door	18"W x 46"H x 14"D
CL1446D	Cabinet Locker Short Door	18"W x 46"H x 14"D

DRAWER MODULES



2-1/2" deep drawers come with ABS divided and removable trays perfect for small parts.

NEW GLIDES!

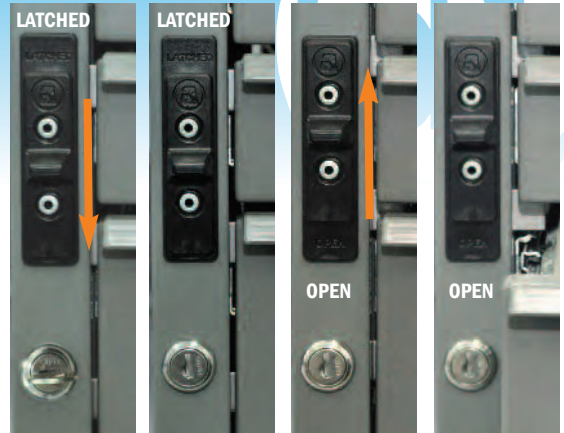

Latched & Locked **Latched & Unlocked** **Drawers Unlatched** **Drawers Open**

Drawer Units - Lock 'n Latch System

- Our exclusive Lock 'n Latch system provides a choice of drawers open, drawers retained or drawers locked position.
- Drawers are made of an engineered composite material for durability with ALL NEW heavy-duty drawer glides for support and smoother drawer operation.
- The new drawer glides significantly increase the ease of use when opening and closing the drawer units. They all but eliminate the rattle noise of the drawers when the driving the vehicle.
- Drawers and glides can be repositioned within cabinet for increased flexibility.
- Divide 5" deep drawers into compartments using optional metal "egg crate" dividers.

Model	Description	Drawer Size (Qty.)
19	2 Drawer Medium	16"W x 5"D x 11-1/2"L (2)
919	3 Drawer Combo	16"W x 2-1/2"D x 11-1/2"L (2) 16"W x 5"D x 11-1/2"L (1)
9	4 Drawer Shallow	16"W x 2-1/2"D x 11-1/2"L (4)
27	Divider Kit	Nos. 19 or 919 Drawer (1) 13-3/4"W x 2-3/4"H x 11-3/4"L

Steel outer cabinet measures 18"W x 12"H x 12"L.

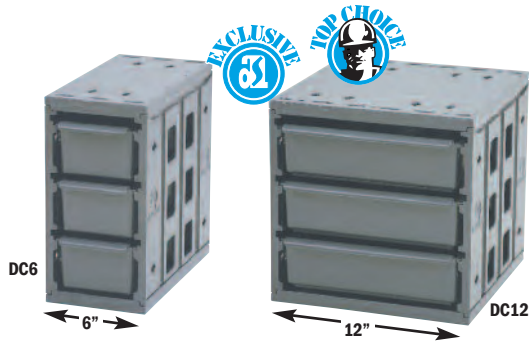

Drawer Components

- Organize small parts with our flexible and rugged composite Drawer Components.
- Drawer retention stops prevent drawers from opening while the vehicle is in transit.
- Made of a hi-impact polymer for a quiet operation.
- Each drawer comes with 2 dividers and 7 divider slots.
- Interlocking feature allows up to 2 units stacked vertically or multiple units horizontally.
- Choose from Adrian Steel's pre-configured drawer systems or create your own drawer system from the base models.

Model	Description	Overall Size
DC6	Base 3 drawer narrow model	6"W x 12"H x 12"D
DC12	Base 3 drawer wide model	12"W x 12"H x 12"D
DS06212V	Drawer System (2) DC12's	12"W x 24"H x 12"D
DS36012H	Drawer System (3) DC6's	18"W x 12"H x 12"D
DS46012	Drawer System (4) DC6's	12"W x 24"H x 12"D

5lb. weight capacity per drawer.

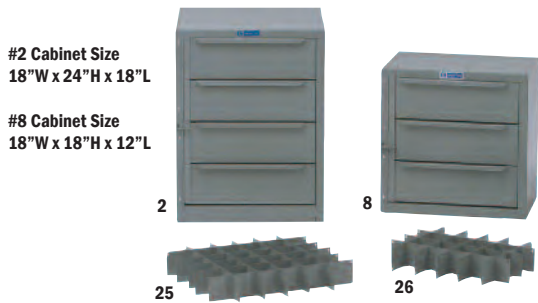

Drawer Units - Locking Hinge and Hasp

- Drawers are welded and have reinforced drawer slides for strength.
- Can be locked with a padlock (not included) for security.
- Divide drawers with optional metal "egg crate" dividers.

Model	Description	Drawer Size (Qty.)
8	3 Drawer Medium	16"W x 5"D x 11-1/2"L (3)
2	4 Drawer Medium	16"W x 5"D x 17-1/2"(4)
25	Divider Kit	No. 2 Drawer (1) 15-1/2"W x 2-3/4"H x 17-1/2"L
26	Divider Kit	No. 8 Drawer (1) 15-1/2"W x 2-3/4"H 11-1/2"L

Tote Trays and Cases

- Take small parts and tools right to the job site with removable tote trays and cases.
- Totes measure 18-1/2"W x 3"D x 12-1/2"L and are available in both steel tray and poly case designs.
- Steel tote trays feature fold-down carry handles and four large storage compartments with adjustable dividers.
- Poly tote cases offer a see-through lid with latches to prevent spilling,, four large compartments and twelve adjustable dividers.
- Trays and cases store in a 19-3/4"W x 20-1/8"H x 13-3/8"L modular rack that can be stacked or floor mounted.



Model	Description	Tote Style (Qty.)
SPT-4	Combo Totes and Rack	Steel Trays (2) Poly Cases (2)
SPT-4P	Poly Totes and Rack	Poly Cases (4)
SPT-4S	Steel Totes and Rack	Steel Trays (4)
SPT-S	Additional Steel Tray	
SPT-P	Additional Poly Tote	

Portable trays

52" AND 42" FULL SIZE VAN MODULES

SIMPLIFY YOUR LIFE BY ORGANIZING YOUR WORK VAN WITH STORAGE MODULES FROM ADRIAN STEEL.

Available in 52", 42", and 36" lengths, these modules are useful combinations of shelving, drawers, cabinets and bins. It doesn't matter what tools and equipment you need to transport to and from the job, Adrian has storage modules to store and organize a variety of things. Regain control of that cargo and spend less time and stress looking for the parts or tools you need.



MD534 Drawer Rack Bin Module combines the convenience of drawers and cabinets with removable plastic bins. Includes Nos. 9, 12(2), 19, 33WB, 40, 43. Measures 52"W, 46-1/2"H, 14"D.



MD535 Drawer Cabinet Module provides easy-to-scan storage with open shelf rack and book file. Includes Nos. 9, 18, 19, 33WB, 40, 43. Measures 52"W, 46-1/2"H, 14"D.



MD537 Cabinet Shelf Module offers divided shelving and lockable storage for tools and parts. Includes Nos. DK552, DV 14(4), 24292. Measures 52"W, 46-1/2"H, 14"D.



MD506 Drawer Cabinet Module combines the convenience of drawers and cabinets. Includes Nos. 9, 12(2), 19, 40, 43. Measures 42"W, 46-1/2"H, 14"D.



MD507 Drawer Rack Module features shelving in addition to drawers. Includes Nos. 9, 18, 19, 40, 43. Measures 42"W, 46-1/2"H, 14"D.



MD508 Workbench Module has masonite work top with mix of small and medium drawers. Includes Nos. 9, 19, 40, 54. Measures 42"W, 26"H, 14/18"D.



MD509 Workbench Module has 31" tall work surface, medium drawers and book file storage. Includes Nos. 8(2), 40, 54, CB2. Measures 42"W, 31"H, 14/18"D.



MD530 Drawer Shelf Module combines the convenience of drawers and divided shelving. Includes Nos. 9, 19, DV14 (4), 29263. Measures 42"W, 46-1/2"H, 14"D.



MD531 Cabinet Module provides a lockable compartment for security and divided shelf storage. Includes Nos. DK542, DV14 (4), 29263. Measures 42"W, 46-1/2"H, 14"D.

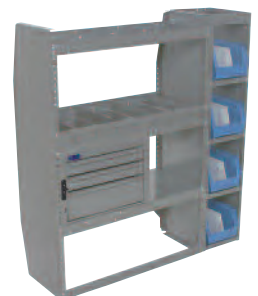

MD532 Cabinet Shelf Module combines small and medium drawers with divided shelving and removable bins. Includes Nos. 33WB, 919, DV14(4), 29682. Measures 42"W, 46-1/2"H, 14"D.

Vehicle fit: Full-size van 52" and 42" Storage Modules are designed to fit over wheelwells and areas indicated on Interior Layout Guides.

Note: When planning your layout, consideration should be given to options such as auxiliary fuel tank inlets, rear cargo heater and air conditioning locations.

How to order: Specify module number. Include make model and year of van when ordering.



MD533 Drawer Shelf Module features divided shelving, lockable compartment and rack with removable bins. Includes Nos. DK532, DV14(4), 33WB, 29682. Measures 42"W, 46-1/2"H, 14"D.



Workbench Module

features 84" of work top surface. Module includes KMB36 Key Machine Base, two No. 54 Workbenches, two No. 9 Four Drawer Shallow, two No. 19 Two Drawer Medium, No. 40 Base and No. 14 Stool. See package 2255.

Model	Description
MD608	Work Bench Module 84"W, 28"H, 18"D

36" & 42" FULL SIZE MODULES



MD501 Quad Cabinet Module has large, individually locking cabinets. Includes Nos. 1(2), 4A, 12(2).
Measures 36"W, 46"H, 12"/18"D.



MD502 Horizontal Rack Drawer/Cabinet Module has welded shelf dividers along top, 1 locking cabinet and 4 medium drawers. Includes Nos. 1, 2, 18, VM12 (2), FA18 (2).
Measures 36"W, 46"H, 12"/18"D.



MD503 Vertical Rack Drawer Module has one locking cabinet, four shelves, and six drawers – two medium, four shallow. Includes Nos. 3, 9, 12, 19.
Measures 36"W, 46"H, 12"D.



MD504 Rack Module provides upright, divided shelving space. Includes Nos. 18(2), 4A.
Measures 36"W, 46"H, 12"D.



MD505 Two Cabinet Drawer Module has locking cabinets and eight medium drawers. Includes Nos. 2(2), 12(2).
Measures 36"W, 46"H, 12"/18"D.



MD526 KD Storage Unit includes 18 pigeon hole compartments, a No. 36 18-Drawer unit and three jumbo drawers.
Measures 36"W, 46"H, 12"D.



MD510 KD Storage Module includes the No. 36 18-Drawer unit and three jumbo drawers measuring 11"W, 4-1/2"H, 11"D.
Measures 36"W, 36"H, 12"D.



MD511 Drawer Cabinet Module has one locking cabinet, six drawers - two medium, four shallow. Includes Nos. 4B, 9, 12, 19, 99.
Measures 36"W, 37"H, 12"D.



MD512 Rack Module provides upright divided shelving space, shelf on bottom. Includes Nos. 18, 99.
Measures 36"W, 36"H, 12"D.



MD513 Cabinet Module has two large cabinets. Key locking doors. Includes Nos. 12(2), 99.
Measures 36"W, 36"H, 12"D.



MD525 42" Workbench Module has masonite tabletop and six drawers – two medium, four shallow. Includes Nos. 9, 19, 54, 98.
Measures 42"W, 28"H, 14"/18"D.



MD527 42" Shelf Cabinet Module has one large, locking cabinet, shelf space above. Includes Nos. MD524, DK546.
Measures 42"W, 36"H, 12"D.



MD517 KD Storage Module features No. 36 18-Drawer Unit. Includes 12 pigeon-hole compartments rather than three jumbo drawers. Compartments measure 6"W, 5"H, 12"D.
Overall 36"W, 36"H, 12"D.



99 Wheelhouse Frame supports the components of your choice (drawer units, cabinets, etc.) over the wheelhouse of the van.
Measures 36"W, 36"H, 12"D.

98 Workbench Frame (not pictured) is used to hold components of your choice.
Measures 42"W, 24"H, 12"D.

Full Size Van Vehicle fit:
Full-size van 36" Storage Modules are designed to fit in the forward left section of the van. They can also be placed inboard of the street and curbside wheelwells if "flush fronts" or full center aisle space is not required.

Note: When planning your layout, consideration should be given to options such as auxiliary fuel tank inlets, rear cargo heater and air conditioning locations.

How to order: Specify module number. Include make model and year of van when ordering.

Adrian Steel Distributors can help you design the cargo management solution you need. Give them a call today.

STORAGE & DRIVER DATA FILES

KEEP WORK ORDERS AND INVOICES ORGANIZED AND SECURE WITH ADRIAN'S DATA AND STORAGE FILES.

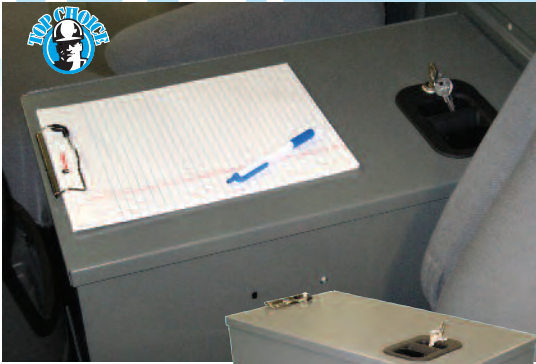

DDF12 Driver Data File
12" W, 18" H, 22" D
Fits Full-Size Vans



Driver Data Files

- Designed to mount between the front seats.
- Rugged steel construction with a hinged worktop and key locking paddle handle.
- Convenient lid mounted clip holds papers in place on the writing surface.
- Includes built-in rails for hanging standard and legal size file folders.
- Data Files mount securely to the vehicle floor, and can be removed for service.



CH1 Optional Cup Holder
Fits DDF12 and DDF7



DDF7 Driver Data File
7" W, 18" H, 22" D
Fits All Full-Size, and Mini Vans

Aluminum Lock Box

- Stores valuable tools and paperwork.
- Gas shock safely opens and closes the large lid.
- The large lock will accommodate a padlock or hockey puck style lock (not included.)
- Designed to mount on the van floor facing out the side or rear doors.
- Aluminum construction with powder coat black paint.



LKB1 Aluminum Lock Box
20" W, 14.5" H, 25" D



1: CB5 Five Slot Literature Holder Mount on partition or other vertical surface. 2-1/2" deep pockets. Overall size: 12"W, 24"H, 2-1/2"D.

2: CB7 Seven Slot Literature Holder Mount on partition or other vertical surface. 6-3/4" deep pockets. Overall size: 14-3/4"W, 28-7/8"H, 7"D.

3: 17A Six Shelf Catalog File Designed for catalogs but also serves to store a variety of materials between the 3" shelf spacings. Overall size: 11"W, 24"H, 12"D.

4: 43 Three Shelf Catalog File Fits in narrow spaces. It has three declined shelves. Perfect for binders and catalogs. Overall size: 6" W, 34" H, 12" D.

5: BH4 Four Slot Binder Holder Designed to mount on partition or almost any vertical surface. Excellent for binders. Each pocket is 2 1/2" deep. Overall size: 12-3/4" W, 19-1/2" H, 2-1/2" D.

6: CB2 Two Book File Mounts on the floor between front seats and partition. Holds folders 12"H x 10-1/2"D. Overall size: 6"W, 14"H, 12"D.

7: CB3 Three Book File Mounts on cabinet tops or on the floor. Multiple units can be flush-mounted. Holds folders 12"H x 10-1/2"D. Overall size: 10-3/4"W, 14"H, 12"D.

8: CB4 Utility Storage Box Stores a variety of printed material. Also suitable for keeping tools, safety glasses, gloves and other items. Hinged lid. Overall size: 12"W, 12"H, 14"D.

FLOOR DRAWERS



ADRIAN'S STOW-ALL IS THE FINEST FLOOR STORAGE UNIT YOU CAN BUY.

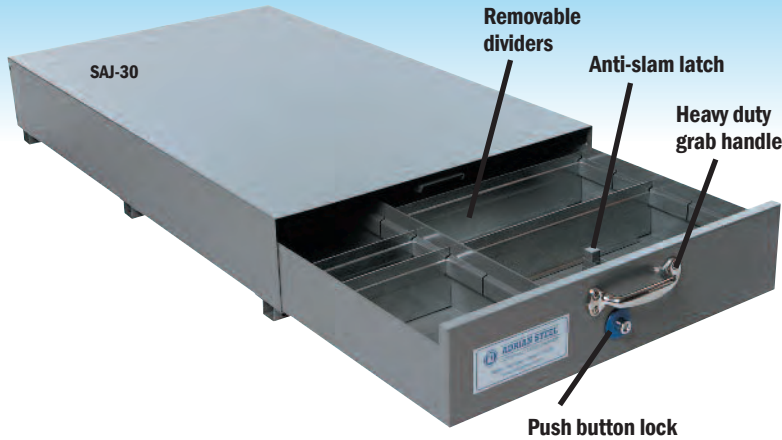

- 14 Gauge steel outer cabinets are constructed with top channel cross support members for strength and rigidity.
- Drawers are constructed with double sidewalls to prevent bowing and to accommodate items up to 48" in length.
- The anti-slam latch stops drawers from completely closing without positive latch activation.
- Heavy-duty grab handle and push button lock allows for comfortable, one-handed drawer operation.
- Durable powder coat finish will provide years of rugged service.
- Easy glide drawers with full width recessed conveyor roller at front and hardened steel roller bearings at rear.
- Install at rear or side doors, and units can be stacked.

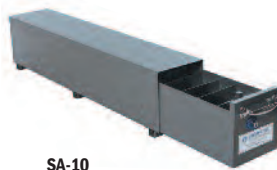

SA-10



SA-20



SA-40

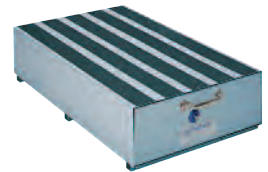

Stow-All Deep Series

Model	Description	Cabinet Size	Drawer Size	Traction Kit	Divider (Qty.)
SA-10	Single Wide Deep	10"W x 12"H x 51-1/2"D	9-5/8"W x 8-1/2"H x 48-1/2"D	TK10	DV9(5)
SA-20	Double Wide Deep	20"W x 12"H x 51-1/2"D	19-5/8"W x 8-1/2"H x 48-1/2"D	TK20	DV19(5)
SA-40	Full Wide Deep	40"W x 12"H x 51-1/2"D	9-5/8"W x 8-1/2"H x 48-1/2"D (2) 19-5/8"W x 8-1/2"H x 48-1/2"D	TK40	DV9(10) DV19(5)

Traction Kits are available to provide a positive friction surface for better footing. Traction Kits are 4" wide, self-adhesive strips.



SAJ-10



SAJ-20



SAJ-30



SAJ-40

Additional Dividers are available and are sold individually.

Stow-All Shallow Series

Stow-All quality in a lower profile

Model	Description	Cabinet Size	Drawer Size	Traction Kit	Divider (Qty.)
SAJ-10	Single Wide Shallow	10"W x 8-1/2"H x 51-1/2"D	9-5/8"W x 5-1/4"H x 48-1/2"D	TK10	DVJ9(5)
SAJ-20	Double Wide Shallow	20"W x 8-1/2"H x 51-1/2"D	19-5/8"W x 5-1/4"H x 48-1/2"D	TK20	DVJ19(5)
SAJ-30	Triple Wide Shallow	30"W x 8-1/2"H x 51-1/2"D	9-5/8"W x 5-1/4"H x 48-1/2"D	TK30	DVJ9(5) DVJ19(5)
SAJ-40	Full Wide Shallow	40"W x 8-1/2"H x 51-1/2"D	9-5/8"W x 5-1/4"H x 48-1/2"D (2)	TK40	DVJ9(10)

ALUMINUM FLOOR DRAWERS ARE LOADED WITH FEATURES!

- Adrian Steel exclusive Anti-Slam latch keeps drawer from closing without positive latch activation. The only aluminum drawer in the industry with this feature!
- An automotive grade lock keeps expensive cargo secure and the adjustable divider helps keep contents segmented.
- The integral latch keeps the drawer open when you are on an incline and closed when you're done!
- Heavy duty grab handles and ball bearing slides allow the drawer to open and close with ease.
- Can be stacked to utilize large cubic storage areas.
- 24" deep units have a weight capacity of 350 lbs. and the 36" deep have a 325 lb. weight capacity.



AFD181236
weight 52lbs.



AFD241224
weight 46lbs.

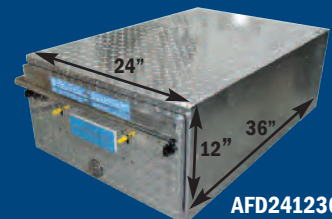

AFD241236
weight 60lbs.

VAN ACCESSORIES

ADRIAN'S BLUE BIN SYSTEM IS PERFECT FOR VISUAL INVENTORY MANAGEMENT.

- 6" and 12" bins maximize the ADseries shelf space.
- The innovative rail system locks the bins in place on the shelf.
- The bins can nest on top of each other when at the job site or in the warehouse getting filled to go.
- Add a label to the front so you can find parts quickly
- Each bin can accommodate one optional divider.

Order our predefined bin systems or create your own configuration of bins. Please note that the bins and the rail are a system. To obtain all the features listed above, both must be ordered.



SBIN120614



SBIN060614



BR36212 Bin System on an AD44FP ADseries shelf unit.

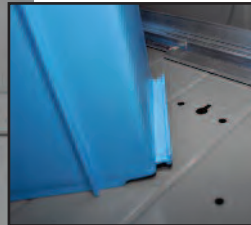

Bins lock into place along the rail for secure transport.

Model	Description
SBIN060614	6" Blue Bin
SBIN120614	12" Blue Bin
SBINDIV	Divider
BR36212	Bin System: 3-6" & 2-12" bins w/rail
BR76012	Bin System: 7-6" bins with rail
SRAILAD26	26" Retention rail
SRAILAD32	32" Retention rail
SRAILAD44	44" Retention rail
SRAILAD50	50" Retention rail

PROTECT YOUR VAN AND CARGO WITH ADRIAN STEEL FLOOR MATS.



Reduce floor wear, cargo shift and interior noise.

Commercial grade

Durafloor Cargo Mats

Better than plywood!

This floor system superior to plywood or rubber matting. It is a non-slip material that is odorless, non-toxic, easy to use and cuts like wood. Better than wood, it's everlasting.

- Weather and Waterproof
- Chemical and corrosion resistant
- Fire Retardant
- Precut to fit specific interior cargo area

89-GMVTO GM Full Size LWB Vans (3 sections)
89-GMXVTO GM Full Size XLWB Vans (3 sections)

Notes: Durafloor mats are not compatible with plastic van liners. Due to the manufacturing process of the Durafloor, there may be a slight color variance between sections.

Floor Mats are die-cut for wheelwells and meet flammability test MVSS 302. Made of 3/16" rubber, diamond corrugated pattern. Side stepwell and seat pedestals require some trimming.

- 88-2** GM Full Size LWB Vans
- 88-9** GM Full Size XLWB Vans

SAFELY TRANSPORT REFRIGERANT TANKS IN AN ADRIAN STEEL TANK RACK.



Vertically carry 30-lb. and 50-lb. refrigerant tanks securely in your van. Tank Racks can be installed for easy access from the side or rear van doors. Racks feature 14-gauge tubular steel frames welded for strength with sloped cradles and nylon straps. The optional **WTRTRAY** provides a storage area mounted on top of the welded tank racks.* The tray can be mounted to any size tubular tank rack.

Model	Description
WTR130250	(1) 30 lb & (2) 50 lb tanks
WTR230150	(2) 30 lb & (1) 50 lb tanks
WTR330	(3) 30 lb tanks
WTR350	(3) 50 lb tanks
WTR430	(4) 30 lb tanks



*Please confirm the location of the tank rack and tray, some interior locations will not accommodate the tray due to the contour of the vehicle.

VAN ACCESSORIES

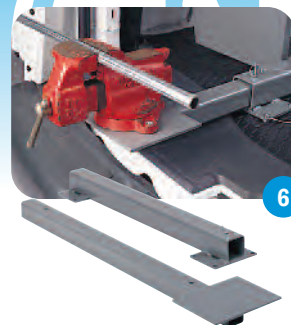
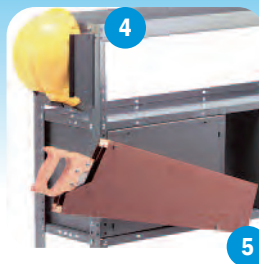

1: DST21 Door Storage Tray offers convenient access to parts and tools.

Overall size: 20" W, 4" D, 8" H

2: Aerosol Can Tray secure cans for easy access.

ACT3 - 3 Can Tray Overall size: 11-3/4" W, 4" D, 6-3/4" H

ACT4 - 4 Can Tray Overall size: 15-7/16" W, 4" D, 6-3/4" H

3: 14 Step Stool has a wide base and is 12" high. Stool can be used as a workbench or auxiliary step. Top measures 10" x 20" One size.

4: TA2 Hard Hat Holder secures hat to partition or shelving.

5: TA3 Saw Holder holds two hand saws.

6: VMA36 Vise Mount Assembly is floor mounted and telescopes out beyond side or rear cargo doors when fully opened. Measures 36" closed and 60" open.

7: 53-9 Roof Vent include gasket, trim shroud, screen and a two-way, snap-open hinge handle. Prime coat finish

8: Touch-Up Paint in spray cans match Steel-Cote™ finish. Three colors:

STP12G - Gray **STP12W** - White **STP12B** - Black

9: Door Tray comes with two dividers and has optional lid for containment.

DT21 - Door Tray Overall size: 18" W, 4" D, 4" H

DTL21 - Door Tray Lid for DT21 only

DTWL21 - Door Tray with Lid Overall size: 20" W, 4" D, 4" H

10: Parts Tray features a 2" deep shelf lip. Can be mounted to cabinet and drawer modules for added top storage.

4A - Parts Tray Overall size: 36" W, 12" D, 2" H

4B - Parts Tray Overall size: 18" W, 12" D, 2" H



Storage for small parts

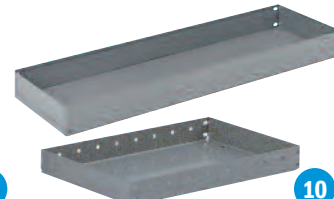

REEL HOLDERS

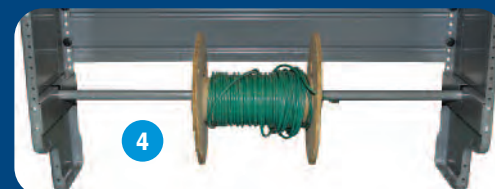

1: CRH2 Cable Reel Holder features a durable frame, two steel shafts that holds up to a 15-1/2" diameter reel by 14" wide. Overall size: 19-1/8" W, 16" D, 44-7/8" H

2: KDRH2 Cable Reel Holder holds large spools up to 16" wide and 18" in diameter. Spools nest on conveyor rollers. Includes tie-down chains with neoprene covers. Overall size: 18" W, 46" H, 18" D

3: WRH5 Wire Reel Holder Five removable bars hold wire spools up to 6" in diameter. Reel Holder mounts to shelf ends or any vertical surface. Overall size: 12" W, 25" H, 4" D

4: End Panel Reel Holder Bar mounts between ADseries shelf end panels for easy access to spools of cable and wire.

KDRH1426 - fits 26" shelf
KDRH1444 - fits 44" shelf

KDRH1432 - fits 32" shelf
KDRH1450 - fits 50" shelf

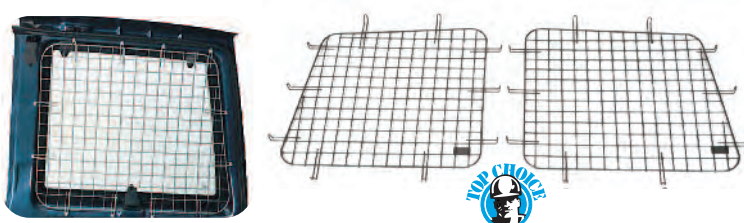

Wire Window Screens add security to cargo area windows.

60-25 & 60-26 GM Full Size Van Curb Sliding Door
60-21 & 60-22 GM Full Size Van Curb Hinged Door
60-23 & 60-24 GM Full Size Van Rear Hinged Door

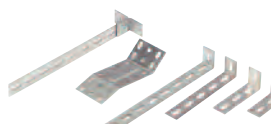

Mounting Brackets

Model	Description
MB111	Offset, 3" x 8"
MB112	L-Style, 1-5/8" x 4-5/8"
MB113	L-Style, 1-5/8" x 7-5/8"
MB114	L-Style, 1-5/8" x 12-1/8"
MB115	T-Style, 3-1/4" x 13"
MB116	L-Style, 1-5/8" x 3-1/8"



Hooks

Model	Description
UH10	1" hook
UH25	2-1/2" hook
UH50	5" hook
TA1	4 Hook Bar



Cargo Straps

Model	Description
CS9	9" strap
CS15	15" strap
CS21	21" strap
CS31	31" strap

LOADSRITE DROP-DOWN LADDER RACK

LOADING LADDERS JUST GOT DOWN RIGHT EASY.

Adrian's LOADSRITE Ladder Racks easily raise and lower to eliminate the need to climb, stretch or reach for your ladder on top or your van. The unique design of the LOADSRITE presents the ladder in a diagonal position bringing it to a comfortable working height in the right way. LOADSRITE, the right way to load and unload ladders.



1. Easy Reach Handle



2. Glide-Out Bed Platform



3. Hydraulic Load Assist



4. Ladder Pivot Pad

LOADSRITE keeps loading and unloading from being a pain in the back.

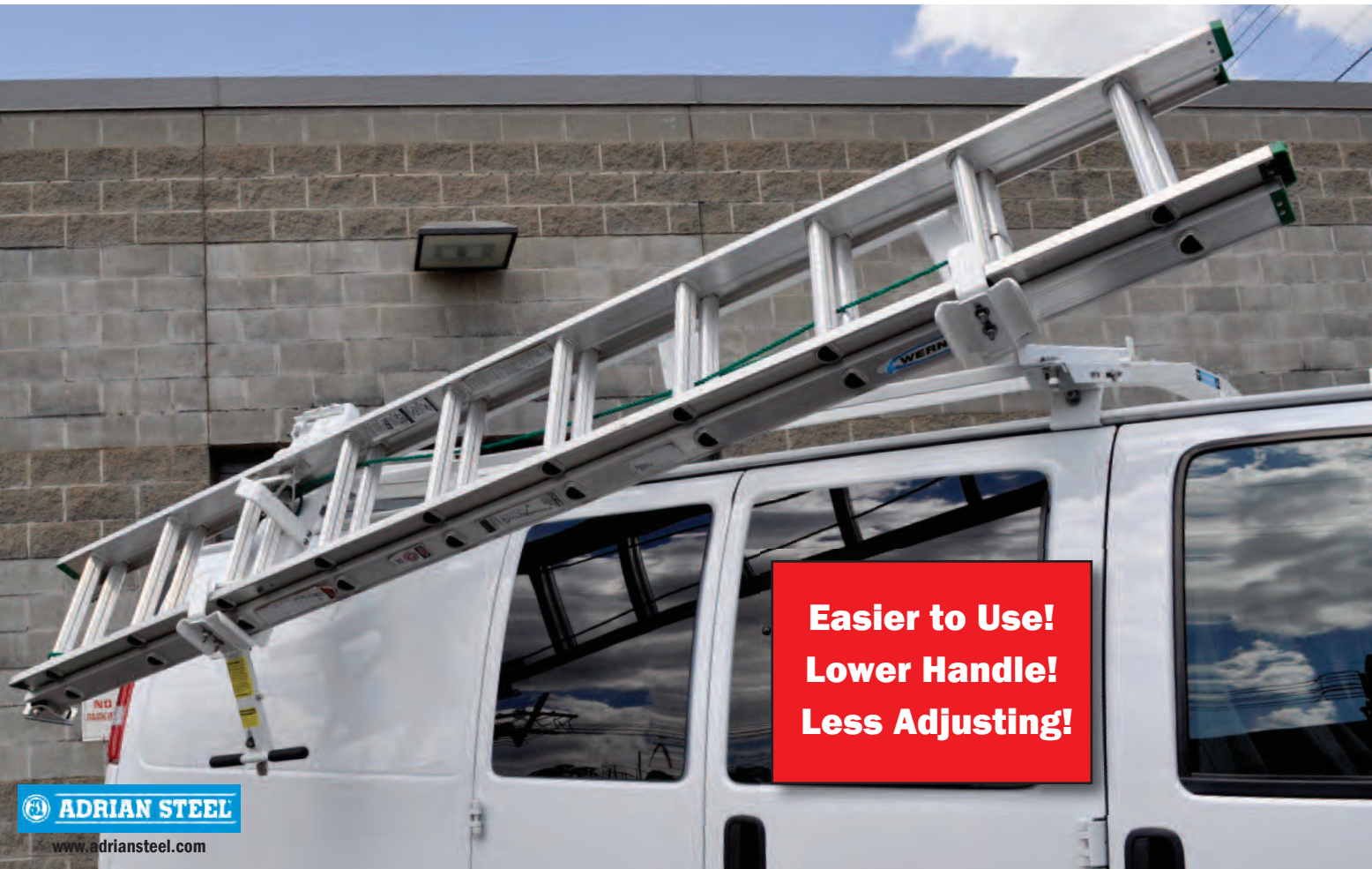

**Easier to Use!
Lower Handle!
Less Adjusting!**

LOADSRITE DROP-DOWN LADDER RACK



Features & Benefits

- Aluminum bed frame, cast aluminum grab handle, stainless steel latch and all stainless steel fasteners.
- Allows side and rear door access while in the up or down position.
- Ladders can be padlocked for security.
- Hydraulic speed damper gently lowers ladder bed.
- Steel-Cote™ diamond-hard powder coat finish-for quality.
- Easy operation from the side of the vehicle.
- There are no straps to deal with, clamping of ladder is automatic.
- Rear bed lowers to present ladder at a convenient position.

Note: LoadsRite is not compatible with GM Pro/Access Van.

Note: Carries 7 to 36 foot extension ladders and 7 to 8 foot step ladders. 10'-12' step ladders with optional step ladder kit LRSLK612.



Scan to see
the LoadsRite
in action!

Description	Model	Support Front to back	Spacing Side to side
Full-Size Vans			
Single LoadsRite Ladder Rack	LR6100WCF or WSF*	84"	70"
Single LoadsRite Add-On Kit for Grip-Lock Ladder Racks	LR6200WCF or WSF*	84"	70"
Double LoadsRite Ladder Rack	LR6300WF	84"	70"
Combo LoadsRite Ladder Rack	LR6400WCF or WSF*	84"	70"
10'-12' Step Ladder Kit	LRSLK612	N/A	N/A

*Note: LoadsRite is ordered preconfigured for the streetside or curbside

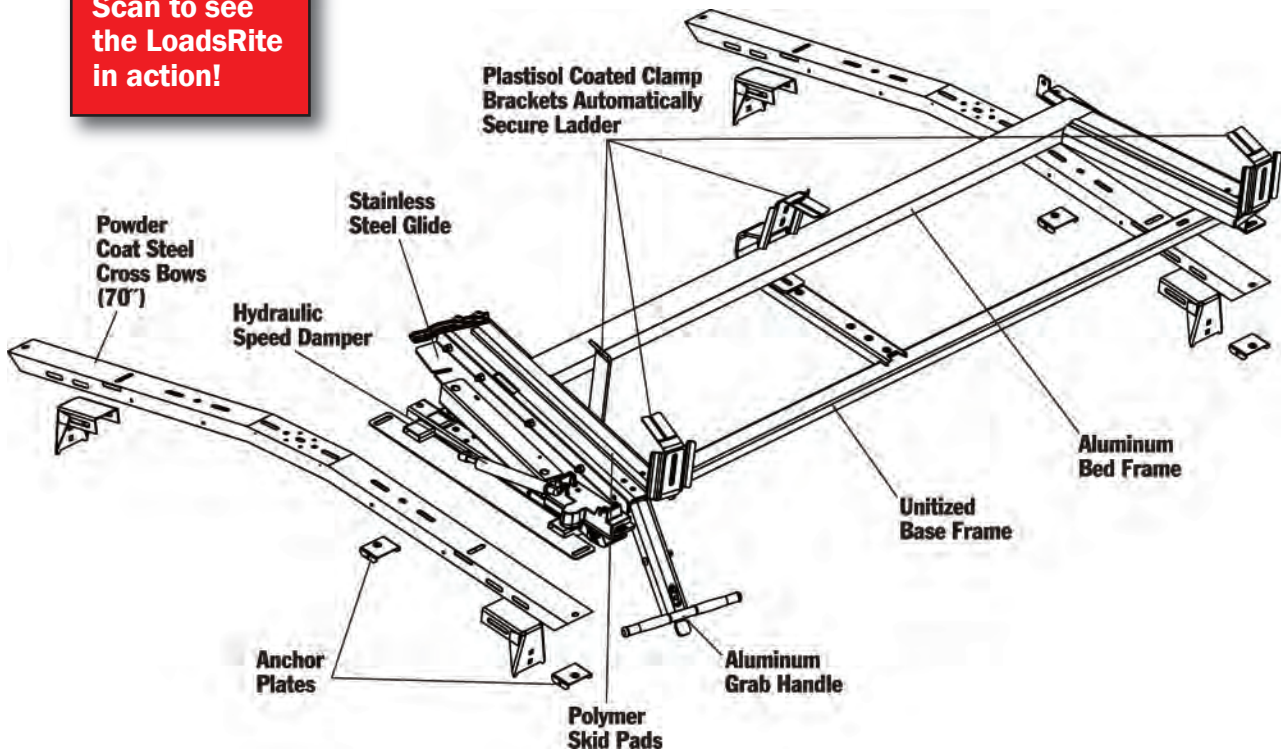

**Do you currently have a Grip Lock ladder rack?
Upgrade to the LOADSRITE easily with the LR6200!**

GRIP-LOCK LADDER RACKS

GRIP YOUR LADDERS SECURELY WITH ADRIAN'S LOCKING STYLE LADDER RACKS.

Adrian's Grip-Lock racks protect the sides and roof of your van during loading and unloading ladders. All Grip-Lock racks feature a lockable, gripping mechanism which firmly secures one or two ladders to the top of the van. Racks easily adjust for ladders of different sizes. Galvanneal plated steel. For a tight grip. For lasting quality—within arms reach!



SERIES 61 Single Grip-Lock rack provides lock-down mechanism for one ladder.

SERIES 63 Double Grip-Lock rack provides lock-down mechanism for two ladders. All Grip-Lock ladder racks feature heavy-duty handle latch for security.

SERIES 64 Combo Ladder rack combines the features of a 24" ladder rack extension for longer ladders with the stepladder support kit on the Double Grip-Lock ladder rack.



Tip: Adjusting the clamp brackets for your ladder is important to keep the ladder safe and secure.

GRIP-LOCK LADDER RACKS



Features & Benefits

- Heavy-Duty actuating arm firmly grips ladder rungs to prevent shifting of ladder on rack.
- Gripping mechanism is lockable.
- Polymer adhesive pads protect ladder rails from contact damage.
- Rung grips easily adjust to accommodate different types of ladders.
- Key structural members receive durable undercoat of galvanneal plating for weather protection and corrosion resistance.
- Steel-Cote™ diamond-hard powder coat finish—for quality.
- Mounts to drip-rails on full-size vans for easy installation.

Style	Model	Description	Support Front to back	Spacing Side to side
Full-Size Vans				
SERIES 61 Single Lock-Down	61-1	Full-Size Vans	84"	71"
SERIES 63 Double Lock-Down	63-1	Full-Size Vans	84"	71"
SERIES 64 COMBO Double Lock-Down	64-1	Full Size Vans	108"	71"
		Includes Aux. Ladder Support 24" Ladder Rack Ext.		
STEPLADDER KIT	68-3	Auxiliary Ladder Support	N/A	N/A
EXTENSION KIT	69-4	24" Ladder Rack Extension	N/A	N/A
RAIL COVER KIT	76	Protective cover for all ladder rack rail and horn	N/A	N/A
Conduit Carrier	80-1	10' 6" Aluminum Conduit Carrier	N/A	N/A
Conduit Carrier	80-2	12' 6" Aluminum Conduit Carrier	N/A	N/A

CUSTOMIZE YOUR GRIP LOCK LADDER RACK FOR YOUR LADDER CARRYING NEEDS.



69-4 Extension Kits

Ladder rack extension kits add 24" to overall length for longer ladders. Kit includes plastisol side rails and cross support with two polymer ladder pads.

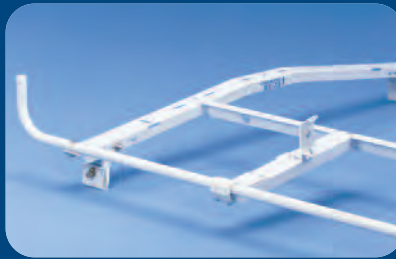

68-3 Step Ladder Support Kits

carry step ladders shorter than the distance between the front and rear cross supports. Kit includes one polymer adhesive-back ladder pad.



Protection for fiberglass ladders

76 Rail Cover Kit includes covers for ladder rack horn and rail to protect ladder rails from contact damage.



80-1, 80-2 Aluminum Conduit Carriers feature a lift-up door for easy access and lockable swivel closure for security.

UTILITY RACKS

ALL NEW DESIGN 2B STEEL UTILITY RACK

- The new design has eliminated much of the welding. **This feature reduces corrosion up to 80% more compared to similar goal-post style racks!**
- The uprights are fully plastisoled to protect against wear and reduce ladder fatigue.
- Uprights feature a number of attachment points for securing cargo straps.
- Designed to fit full size vans.
- Weather resistant cross bar is not cut to fit or perforated in any way improving longevity of the rack.
- Available in our durable black or white powder coat paint.
- Optional center bar supports shorter lengths and provides center support.

Product	Model	Description
Steel/Full-Size Van		
One Bar/ Steel	1BRS-B	Mid Cross Beam Assembly/Black
One Bar/ Steel	1BRS-W	Mid Cross Beam Assembly/White
Two Bar/ Steel	2BRS-B	Black
Two Bar/ Steel	2BRS-W	White
Side Stop Kit	SSK-BS	Black
Side Stop Kit	SSK-WS	White



2B ALUMINUM UTILITY RACK

- Extra wide mount foot and welded tie hooks
- No drilling or cutting required to install prevents exposing metal to the weather
- Available in our durable black or white powder coat paint.
- Upright caps protect ladders when loading and unloading
- Optional center bar supports shorter lengths and provides center support.

Product	Model	Description
Aluminum/Full-Size Van		
One Bar/ Aluminum	1BAR-B	Mid Cross Beam Assembly/Black
One Bar/ Aluminum	1BAR-W	Mid Cross Beam Assembly/White
Two Bar/ Aluminum	2BAR-B	Black
Two Bar/Aluminum	2BAR-W	White
Side Stop Kit	SSK-BA	Black
Side Stop Kit	SSK-WA	White

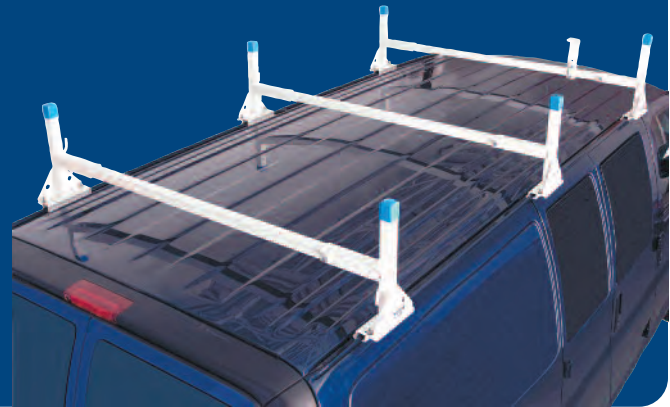

HD 2BAR UTILITY RACK

- Features extruded aluminum cross bars and extra wide, cast aluminum mounting foot
- Each cross bar includes one adjustable cast aluminum side stop for sectioning loads
- No drilling or cutting required to install
- Universal design to fit GM Full-size vans
- Available in anodized aluminum finish
- Stainless steel foot clamps
- Optional center bar supports shorter lengths and provides center support.



Optional side stop kit keeps load in place on rack.

Product	Model	Description
GM Full-Size Van		
One Bar/Aluminum	HD1BAR	Mid Cross Beam Assembly
Two Bar/Aluminum	HD2BAR	Front and Rear Cross Beam
Side Stop Kit	SSKHD	

UTILITY RACKS



PUT SOME VERSATILITY ON TOP OF YOUR VAN.

The full perimeter frame of Adrian Steel's perimeter racks add strength and support to the rack and provides ample area to tie down cargo. Add accessories to fit your specific cargo carrying needs.

PERIMETER RACKS



Perimeter Racks

Designed for all full-size vans. Gutter mounted—requires no drilling. Crossmembers spaced from front bar are 52", 113" and 130" to slantdown rear bar.

- VP1 Cargo Rack
- VPE1 Optional Rack Extension (for VP1 only)
- Extend front of rack 30" with additional crossmember for extended long wheelbase full-size vans only.

Features & Benefits

- Maximize carrying capacity of van.
- Frame constructed from 2" x 1" 13 GA square tube.
- All racks include rope hooks for easy tie-down.
- Slantdown rear section eases loading.
- Steel-Cote™ finish for lasting protection.

BS6VP Beacon/Strobe Light Stand

raises light above rack for improved visibility.

LS3VP Ladder Stop

provides rung stop and tie off point for ladders. Fits all Cargo Racks.

AS12 Auxilliary Step

mounts to rear bumper of van for access to rack (not shown).

SH12 Step Handle

Mounts to rear corner.

Product	Model	Description
Full-Size Van		
Cargo Rack	VP1	Fits full-size vans
Rack Extension	VPE1	Fits VP1 only - XLWB vans
Center Cross Bar	CC17	Fits VP1 only
Cargo Rack Roller	RR5	Fits VP1 only
Full-Size Van Accessories		
Auxiliary Step	AS12	Fits full-size vans
Beacon/Strobe Light Stand	BS6VP	Fits cargo racks
Ladder Stop	LS3VP	Fits all cargo racks
Ratchet Strap	RS4	Fits VP1 only
Step Handle	SH12	Fits full-size vans
Aluminum Conduit Carrier	80-1	10'6" Conduit Carrier
Aluminum Conduit Carrier	80-2	12'6" Conduit Carrier



RR5 Cargo Rack Roller

makes all your cargo easy-on and easy-off. Fits VP1 only. Includes two U-bolts for mounting.



RS4 Ratchet Strap safely ties down cargo. Locking ratchet action handle with 7 x 1-1/2" strap. Fits VP1 only.

CHANNEL SUPPORT UTILITY RACK & ACCESSORIES



Channel Support Utility Rack Features & Benefits

- 14-gauge steel cross supports.
- 70" carrying surface on full-size vans
- Galvanneal plating undercoat prevents weather-related corrosion.
- Series 66 and 67 Utility Racks also include stop brackets and chain tie-downs.
- Steel-Cote™ finish for lasting protection and durability.

65-1 Base Set for GM Full Size Van

66-1 Single Tie-Down for GM Full Size Van
Includes one Stop Bracket and two Chain Tie-Downs.

67-1 Double Tie-Down for GM Full Size Van
Includes two Stop Brackets and four Chain Tie-Downs.



1



4



5



6



2



3

1: 70-1 4" Diameter PVC Conduit Carrier Kit

contains aluminum cast hinged lid and end cap, two stainless steel "U"-bolts, adhesive sealant and fasteners. Use with 4-1/2" O.D. PVC pipe schedule 40 (not supplied).

70-2 6" Diameter PVC Conduit Carrier Kit Use with 6-5/8" O.D. PVC pipe schedule 40 (not supplied).

2: 71 Ladder Tie-Down Kit includes one forward stop and two chain tie downs.

3: 72 Utility Rack Half Set includes one cross support, outside stops and feet. Fits GM full-size vans.

72-F Utility Rack Half Set fits '96-1/2-on GM vans. Fits at center roof position.

4: 73 Ladder Pad Kit includes four polymer pads with adhesive backs. Protects against contact damage to ladder rails.

5: 75 Light Stand raises light 4" above ladder for improved visibility.

6: 80-1 10'6" and 80-2 12'6" Aluminum Conduit Carrier features a lift-up door for easy access and lockable swivel closure for security.

LADDER KEEPER

STORING LADDERS INSIDE YOUR WORK VAN IS EASY AS 1, 2, 3, WITH OUR NEW LADDER KEEPER.

Designed to be loaded from outside the vehicle, the Ladder Keeper features a spring-loaded clamp that holds the ladder securely in place. Just set the top of the ladder in the front clamp bracket and push it forward until the bottom of the ladder sits in the rear clamp bracket. Can be mounted to the ceiling or wall of the vehicle to keep ladders inside and out of the elements.

Ladder Keeper includes all parts needed to carry up to a 6' ladder in a regular wheel-base van and an 8' ladder in a long wheelbase van. To accommodate larger vehicles or ladders, you will require the LKX extension that provides 4' of additional track.

LK8 - Ladder Keeper Interior Ladder Rack for GM FSV

LKX - Four foot Extension for GM FSV

Store ladders inside your van with the Ladder Keeper!



1 Simply press ladder inward to release rear ladder rung from the rear clamp bracket.



2 Walk the ladder back as the front clamp bracket glides on the track.



3 Remove front rung from the front clamp bracket and you're ready to go to the job site!

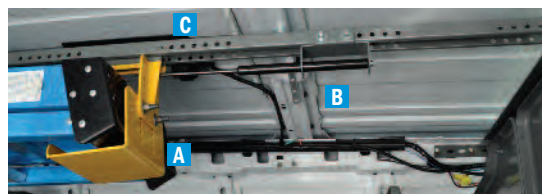

- A** Plastic coated clamps protect ladder rungs
- B** Gas spring compresses ladder for quiet and secure transportation
- C** Extruded track makes loading and unloading simple

GENERAL CONTRACTOR UPFITS



STORAGE SOLUTIONS THAT STAND UP TO THE JOB.

General Contractor packages feature flexibility with adjustable shelving and drop in dividers that can be configured for what you need today and adjusted for what you need down the road. Complete the package with a ladder or cargo rack, a driver data file to organize your paperwork, and a graphic to turn your vehicle into a billboard for your business.

GENERAL SERVICE PACKAGE

4317G GM FSV long wheelbase

4317GX GM FSV x-long wheelbase

Item	Model	Description	Qty
1	AD44FP	ADseries 44" shelf unit	3
2	RKFSVLWB	Rail Kit for AD series	1
3	DV14C8	Divider 8 pack	1
4	919	Three Drawer Combo	1
5	S1M2HC2FSV	Partition	1
6	UH50	Utility Hook	2
7	DK4208	8" Door Kit	2
8	TA1	Hook Bar	1
9	19	Two Drawer Medium	1
10	DC6	Drawer Component - 6"	1
11	BRK14EPS	End Panel Bracket	2
12	WKC2FSVGM	Partition Wing Kit	1



All Trade Packages include a steel cargo partition.

2256G

GENERAL CONTRACTOR PACKAGE

GM Full-Size Long Wheelbase Vans

Item	Model	Description	Qty.
1	DV14	14" Divider	14
2	MD507	Drawer Cabinet Rack Module (includes: #18, #43, #40, #9, #19)	1
3	TA1	Hook Bar	1
4	DK552	Door Kit	1
5	UH50	Hook 5"	2
6	HD-42FP	HD Adjustable Closed End Shelving Overall Size: 46" H, 42" W, 14" D	1
7	HD-52FP	HD Adjustable Closed End Shelving Overall Size: 46" H, 52" W, 14" D	1
8	S1M2C2FSV	Partition	1
9	WKC2FSVGM	Partition Wing Kit	1

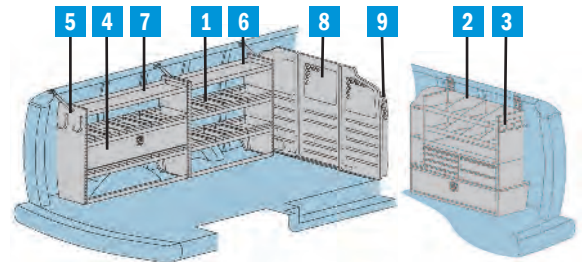

2257G

GENERAL CONTRACTOR PACKAGE

GM Full-Size Long Wheelbase Vans

Item	Model	Description	Qty.
1	12	Open Side Shelf Cabinet	1
2	DV14	14" Divider	16
3	9	Four Drawer Shallow	1
4	19	Two Drawer Medium	1
5	UH50	Hook 5"	4
6	HD-32FP	Heavy-Duty Adjustable Closed End Shelving Overall size: 46" H, 32" W, 14" D	1
7	HD-42FP	Heavy-Duty Adjustable Closed End Shelving Overall size: 46" H, 42" W, 14" D	2
8	S1M2C2FSV	Partition	1
9	WKC2FSVGM	Partition Wing Kit	1

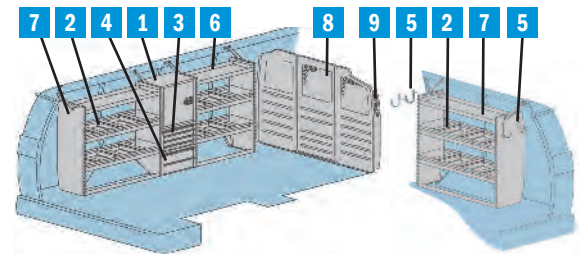

Graphic designed with:



More info on pages 4-5.

Feel like you already work 24/7?
You may not be able to but your van can with a graphics package advertising you!

Make your van WORK READY with a drop-down ladder rack or versatile cargo rack.



pages 22-23

GENERAL SERVICE UPFITS

MAXIMIZE YOUR CARGO VAN STORAGE VOLUME WITH 44 SERIES WELDED SHELVING.

4135G GENERAL CONTRACTOR PACKAGE

GM Full-Size
Long Wheelbase Vans

Free up your interior cargo space by transporting ladders, sheet goods and pipe on a utility or cargo rack.



pages 26-27



Item	Qty	Model	Description
1	(1)	4442	42" Welded Utility Rack
2	(1)	4450	50" Welded Utility Rack
3	(1)	4432	32" Welded Utility Rack
4	(1)	DK550	Door Kit
5	(1)	DV44U4	Dividers
6	(2)	TA1	Hook Bar
7	(1)	CL1446R	Cabinet Locker Tall-Door
8	(1)	9	4 Drawer Shallow

Item	Qty	Model	Description
9	(1)	19	2 Drawer Medium
10	(1)	DC12	Drawer Component - 12"
11	(3)	DC6	Drawer Component - 6"
12	(1)	DK544	Door Kit
13	(3)	28	Plastic Bins
14	(1)	S1M2HC2FSV	Partition (not pictured)
15	(1)	WKC2FSVGM	GM Partition Wing Kit (not pictured)

4136G INDUSTRIAL SERVICES PACKAGE

GM Full-Size
Long Wheelbase Vans

Organize manuals, work orders, invoices and more with a Driver Data File installed in the cab.

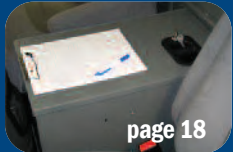

page 18

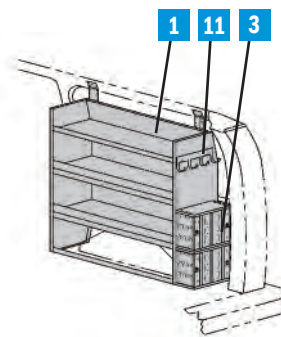
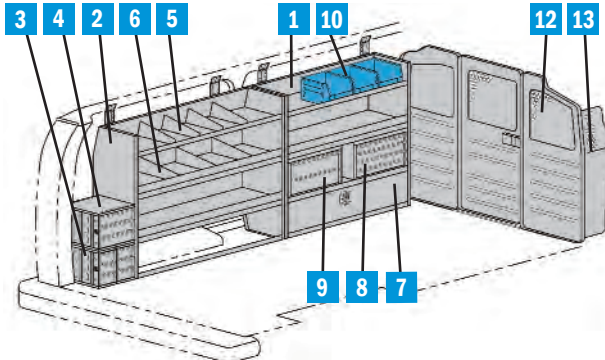

Item	Qty	Model	Description
1	(2)	4442	42" Welded Utility Rack
2	(1)	4450	50" Welded Utility Rack
3	(4)	DC6	Drawer Component - 6"
4	(1)	DC12	Drawer Component - 12"
5	(1)	DV44U4	Dividers
6	(3)	DV44L2	Dividers
7	(1)	DK544	Door Kit

Item	Qty	Model	Description
8	(1)	9	4 Drawer Shallow
9	(1)	19	2 Drawer Medium
10	(3)	28	Plastic Bins
11	(1)	TA1	Hook Bar
12	(1)	S1M2HC2FSV	Partition
13	(1)	WKC2FSVGM	GM Partition Wing Kit

4138G GENERAL STORAGE PACKAGE

GM Full-Size
Long Wheelbase Vans

Add Wire Window Screens for extra cargo area security.

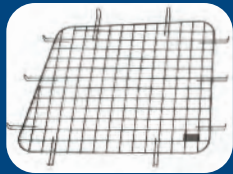

page 21

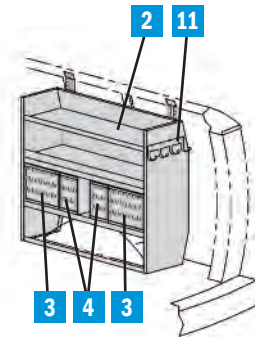
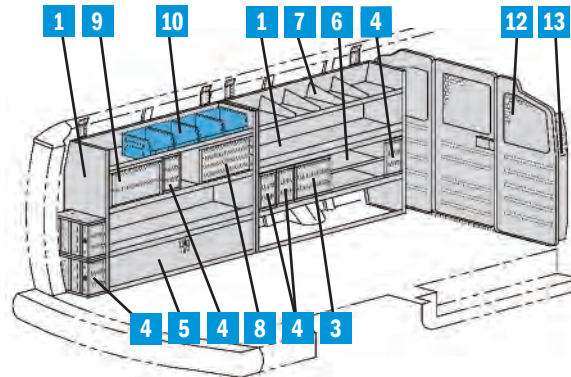

Item	Qty	Model	Description
1	(2)	4450	50" Welded Utility Rack
2	(1)	4442	42" Welded Utility Rack
3	(3)	DC12	Drawer Component - 12"
4	(8)	DC6	Drawer Component - 6"
5	(1)	DK550	Door Kit
6	(2)	SF11218DC	18" wide DC shelf
7	(1)	DV44U4	Dividers

Item	Qty	Model	Description
8	(1)	9	4 Drawer Shallow
9	(1)	19	2 Drawer Medium
10	(4)	28	Plastic Bins
11	(1)	TA1	Hook Bar
12	(1)	S1M2HC2FSV	Partition
13	(1)	WKC2FSVGM	GM Partition Wing Kit

PHVAC UPFITS



STORAGE SYSTEMS THAT ARE AS FLEXIBLE AS YOU ARE.

Is there anything that you don't have in the back of your van? For all the fittings, pipe and tools that you need to transport, you need an Adrian Steel Work Ready van with the trade specific equipment you'll use to do the job and a graphics package advertising what you do.

AD Series

PLUMBING, HEATING & A/C REPAIR PACKAGE

4318G GM FSV long wheelbase
4318GX GM FSV x-long wheelbase

Item	Model	Description	Qty
1	AD44FP	ADseries 44" shelf unit	3
2	RKFSVLWB	Rail Kit for AD series	1
3	DV14C8	Divider 8 pack	1
4	919	Three Drawer Combo	1
5	S1M2HC2FSV	Partition	1
6	WTR230150	Welded Tank Rack	1
7	19	Two Drawer Medium	2
8	DC6	Drawer Component - 6"	3
9	DC12	Drawer Component - 12"	1
10	DK4208	8" Door Kit	2
11	TA1	Hook Bar	1
12	VMA36	Vice Mount Assembly	1
13	BRK14EPS	End Panel Bracket	1
14	RKAWTR	Tank Holder Adapter	1
15	WKC2FSVGM	Partition Wing Kit	1



All Trade Packages include a steel cargo partition.

2251G PHVAC PACKAGE

GM Full-Size Long Wheelbase Vans

Item	Model	Description	Qty.
1	DS36012H	Drawer System	1
2	4442	Welded Shelf Rack	2
3	MD507	Drawer Cabinet Rack Module (includes: #18, #43, #40, #9, #19)	1
4	DK544	Door Kit	1
5	VMA36	Vise Mount Assembly	1
6	TA1	Hook Bar	1
7	TH50	50-lb. Tank Holder	1
8	19	Two Drawer Medium	1
9	WTR230150	Three Tank Rack	1
10	S1M2C2FSV	Partition	1
11	DV44U4	Dividers	1
12	WKC2FSVGM	Partition Wing Kit	1

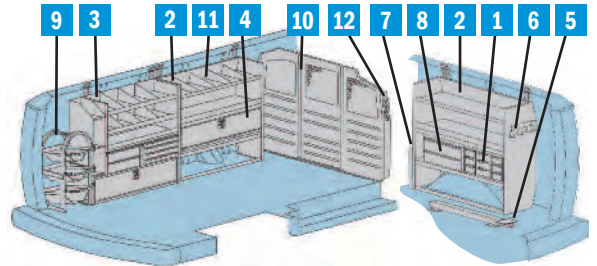

2261G PHVAC PACKAGE

GM Full-Size Long Wheelbase Vans

Item	Model	Description	Qty.
1	4442	Welded Shelf Rack	1
2	DV14	14" Divider	6
3	MD507	Drawer Cabinet Rack Module	1
4	DK544	Door Kit	1
5	TA1	Hook Bar	1
6	DTWL21	Door Tray with Lid and Latches (not shown)	2
7	UH50	Hook 5"	2
8	HD-42FP	Heavy-Duty Adjustable Closed End Shelving Overall Size:46" H, 42" W, 14" D	1
9	S1M2C2FSV	Partition	1
10	DV44U4	Dividers	1
11	WKC2FSVGM	Partition Wing Kit	1

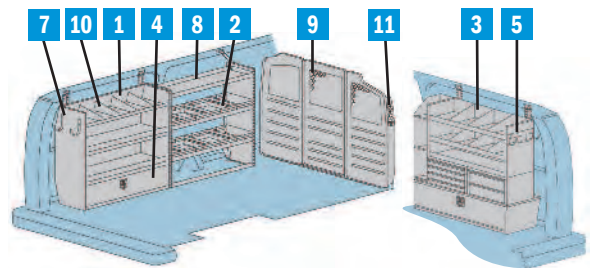

Graphic designed with:



More info on pages 4-5.

Promote your COOL BRAND!
Your business name WILL BE seen with a graphics package for your van!

MAKE YOUR VAN WORK READY:
Have the small fittings, fasteners and parts taken over your van? Stay in control with a Bin Storage System!



page 20

CABLE TV UPFITS

IF IT IS YOUR JOB TO KEEP UP WITH THE LATEST TECHNOLOGY, IT'S OUR JOB TO KEEP THAT TECHNOLOGY ORGANIZED AND EASILY ACCESSIBLE!

Cable TV interiors are designed specifically for service technicians who need to make fast and efficient service and installation calls. Divided shelving and composite drawers are perfect for keeping connectors, adapters, wall plates, cables, splitters and every other small component organized and in its place.

2258G CABLE TV PACKAGE

GM Full-Size
Long Wheelbase Vans

Item	Model	Description	Qty.
1	1	Adjustable Shelf Cabinet	2
2	DS36012H	Nine Drawer System	1
3	PA9	First Aid Tray	1
4	4442	Welded Shelf Rack	1
5	PA8	Fire Extinguisher	1
6	PA7	Reflector Flare Kit	1
7	TA2	Hard Hat Holder	1
8	50-42	KD Shelf Rack	1
9	TA1	Hook Bar	2
10	9	Four Drawer Shallow	1
11	19	Two Drawer Medium	2
12	DDF12	Data File (not shown)	1
13	KDRH2	Cable Reel Holder	1
14	S1M2C2FSV	Partition	1
15	DV44U4	Dividers	1
15	WKC2FSVGM	Partition Wing Kit	1

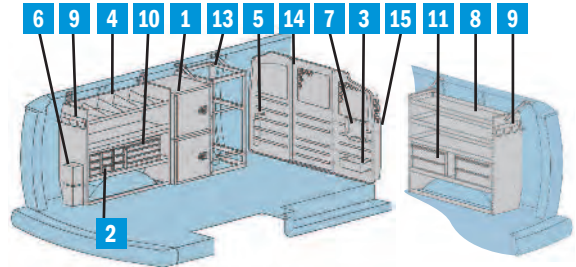

3230G CABLE TV PACKAGE

GM Full-Size
Long Wheelbase Vans

Item	Model	Description	Qty.
1	CL1446R	Cabinet Locker Tall-Door	1
2	MD507	Drawer Rack Module	1
3	TA1	Hook Bar	1
4	WRH5	5-Bar Wire Reel Holder	1
5	4442	Welded Shelf Rack	1
6	50-32	KD Shelf Rack	1
7	S1M2HC2FSV	Partition	1
8	36	18-Drawer Unit	1
9	39	Riser	1
10	DV44U4	Dividers	1
11	WKC2FSVGM	Partition Wing Kit	1

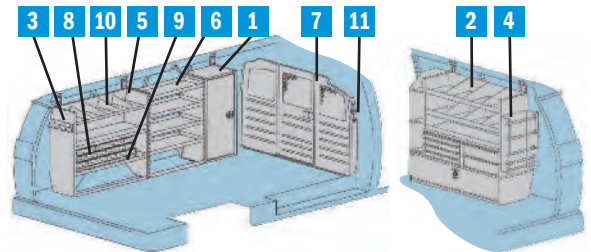

All Trade Packages include a steel cargo partition.

Organize connectors, splitters, adapters and many other small parts in an SPT Tote and tray system. Removable trays have small, divided compartments for easily identifying and choosing what you need to take to the jobsite.



page 20

COMMUNICATE YOUR BRAND!

If you make a living in a highly competitive market you must stand out from all the others. If your work speaks for itself, shouldn't your van speak for you too?

Get the attention you deserve with a vehicle graphics package from Commercial Curb Appeal!



Graphic designed with:



More info on pages 4-5.

MAKE YOUR VAN WORK READY!

ELECTRICAL CONTRACTOR UPFITS



KEEP EVERYTHING IN ITS PLACE AND EASILY ACCESSIBLE.

Time is money, and no one wants to pay you to dig through your van to find the connectors, junction boxes or tools you need to do the job. You don't want to wait either, so get your interior, ladder rack and graphics wrap all done at one place.

ELECTRICAL & GAS APPLIANCE REPAIR PACKAGE

4319G GM FSV long wheelbase
4319GX GM FSV x-long wheelbase

Item	Model	Description	Qty
1	AD44FP	ADseries 44" shelf unit	3
2	RKFSVLWB	Rail Kit for AD series	1
3	DV14C8	Divider 8 pack	1
4	919	Three Drawer Combo	1
5	S1M2HC2FSV	Partition	1
6	WRH5	Wire Reel Holder	1
7	19	Two Drawer Medium	1
8	DK4208	8" Door Kit	2
9	DC6	Drawer Component - 6"	3
10	DC12	Drawer Component - 12"	1
11	9	Four Drawer Shallow	1
12	TA1	Hook Bar	1
13	BRK14EPS	End Panel Bracket	3
14	WKC2FSVGM	Partition Wing Kit	1

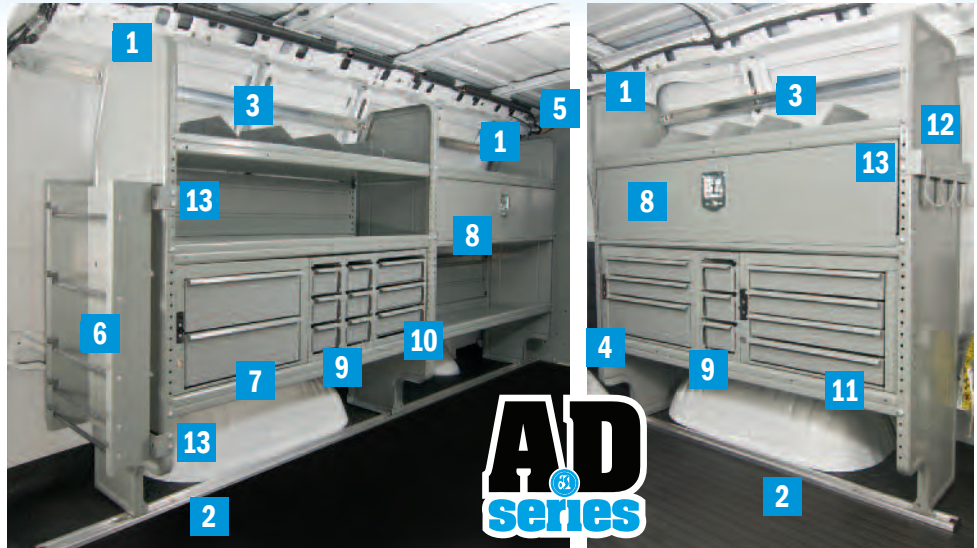

2252G ELECTRICAL CONTRACTOR PACKAGE

GM Full-Size Long Wheelbase Vans

Item	Model	Description	Qty.
1	DS36012H	Nine Drawer System	1
2	4442	Welded Shelf Rack	1
3	DV44U4	Dividers	1
4	DV14	14" Divider	8
5	MD507	Drawer Cabinet Rack Module (includes: #18, #43, #40, #9, #19)	1
6	DK542	Door Kit	1
7	TA1	Hook Bar	2
8	19	Two Drawer Medium	1
9	HD-42FP	Heavy-Duty Adjustable KD Shelving Overall Size: 46" H, 42" W, 14" D	1
10	WRH5	5-Bar Wire Reel Holder	1
11	S1M2C2FSV	Partition	1
12	WKC2FSVGM	Partition Wing Kit	1

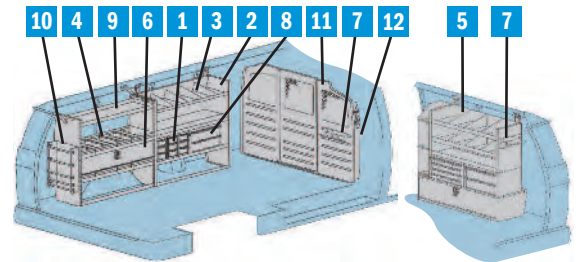

2262G ELECTRICAL CONTRACTOR PACKAGE

GM Full-Size Long Wheelbase Vans

Item	Model	Description	Qty.
1	4442	Welded Shelf Rack	1
2	DV14	14" Dividers	6
3	MD506	Drawer Cabinet Module (includes: 2-#12, #43, #40, #9, #19)	1
4	DK544	Door Kit	1
5	TA1	Hook Bar	1
6	DTW21	Door Tray with Lid and Latches (not shown)	2
7	UH50	Hook 5"	2
8	HD-42FP	Heavy-Duty Adjustable KD Shelving Overall Size: 46" H, 42" W, 14" D	1
9	S1M2C2FSV	Partition	1
10	DV44U4	Dividers	1
11	WKC2FSVGM	Partition Wing Kit	1

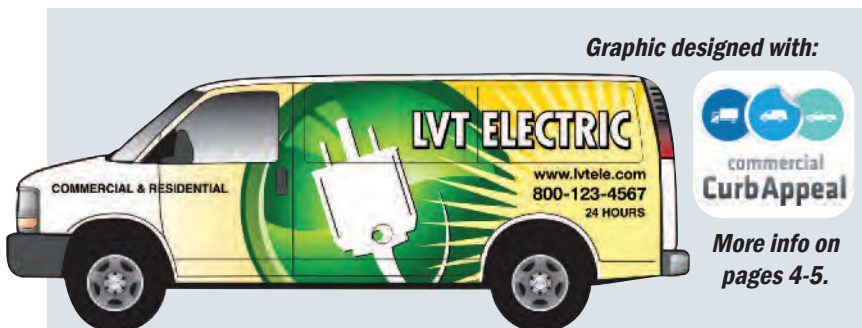
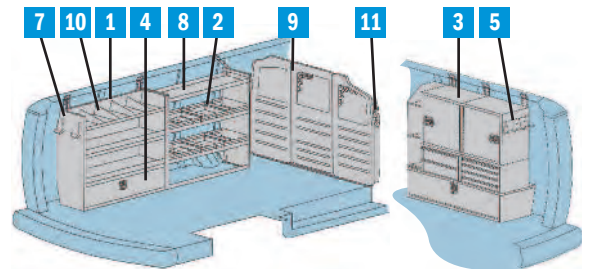

Graphic designed with:



More info on pages 4-5.

Electrify your brand with a rolling billboard at every service call.

MAKE YOUR VAN WORK READY:
 Carry ladders safely and securely on the top of your van with a LoadsRite or Grip-Lock ladder rack.





ALARM & LOCKSMITH UPFITS

THE KEY TO BEING A MOBILE LOCKSMITH IS HAVING EVERYTHING YOU NEED WHEREEVER YOU ARE.

Whether you are helping stranded motorists get back into their vehicle or installing a home security system, having everything needed for the job will keep your work day or night operating efficiently. Both Adrian's Alarm and Locksmith packages feature ample small parts storage and plenty of lockable storage space.

2253G ALARM PACKAGE

GM Full-Size
Long Wheelbase Vans

Item	Model	Description	Qty.
1	33	KD Shelf Rack	1
2	1	Adjustable Shelf Cabinet	1
3	12	Open Side Shelf Cabinet	1
4	DC6	Drawer Componet 6"	3
5	43	Catalog File	1
6	4442	Welded Shelf Rack	1
7	DV14	14" Dividers	8
8	DK544	Door Kit	2
9	TA1	Hook Bar	2
10	2	Four Drawer Medium	1
11	9	Four Drawer Shallow	1
12	19	Two Drawer Medium	1
13	HD-42FP	Closed End Adjustable KD Shelving	1
Over all size: 46"H, 42" W, 14" D			1
14	S1M2C2FSV	Partition	1
15	DV44U4	Dividers	1
16	WKC2FSVGM	Partition Wing Kit	1

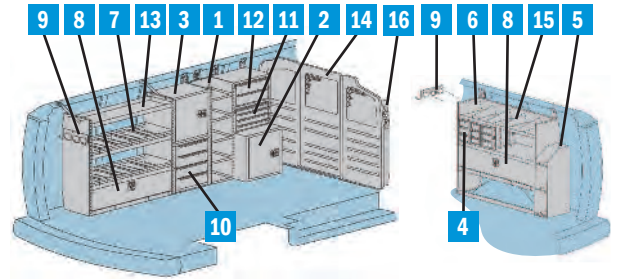

2255G LOCKSMITH PACKAGE

GM Full-Size
Long Wheelbase Vans

Item	Model	Description	Qty.
1	17A	Catalog File	1
2	MD506	Drawer Cabinet Module	1
3	MD608	Workbench Module	1
(includes: 2-#54, #40, 2-#9, 2-#19, #14, KMB36)			1
4	TA1	Hook Bar	1
5	S1M2HC2FSV	Partition	1
6	WKC2FSVGM	Partition Wing Kit	1

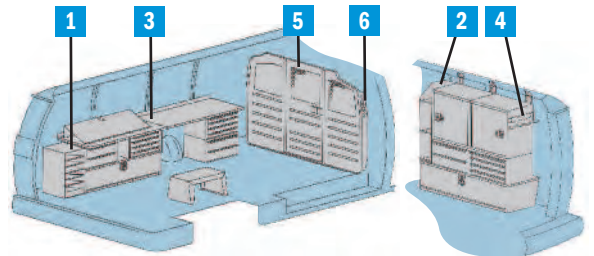

Key Machine Base holds key cutting machines at a 25-degree slope towards the operator for easy cutting. Mounts to No. 54 Workbench. Two sizes available to hold one or two machines.
KMB36 - 36" Key Machine Base
KMB18 - 18" Key Machine Base



25° slope for easy cutting



MAKE IT A WORK READY VAN!

Day and night, you can lock in those leads with a vehicle graphic wrap from Commercial Curb Appeal.

Design your own look and have it installed at the same time as your interior!

Graphic designed with:



More info on pages 4-5.

AUTOMOTIVE GLASS REPAIR UPFITS



THE ONLY VAN INTERIOR DESIGNED AROUND THE AUTOMOTIVE GLASS REPAIR PROFESSIONAL. FEATURING BURCO GLASS RACKS.

Burco S-Series glass racks fit any van and are ideal for loading and unloading from the top or side. They are very adaptable with a variety of widths and mast extensions to best fit your application.



Package shown with S-M-C partition option.

The S-111524B Burco Glass Rack accommodates up to 11 windshields. Designed for modern windshields with six 14.5" and six 23.5" divider posts. The glass rack can transport both taller windshields and smaller glass panels safely. Each post is surrounded with a protective foam cover and a twist and lock top to keep your glass safe and secure.



S-1424B
24" mast height
45"L x 30"W x 27"H



S-09B
15" mast height
30"L x 30"W x 18"H



S-05B
15" mast height
18"L x 30"W x 18"H



AGSS24 shown with AGSCH2 Suction Cup Holder

Storage Station

Store all your window prep supplies (glass primers, razor blades, cleaning supplies, power and hand tools) on the Storage Station. The removable blue bins allow you to take parts with you. The AGSS24 measures 36" high by 12" deep by 42" long.



AGTW4

Trim Weld Storage

Safely store windshield gaskets with the AGTW4. Easily pull out the length you need and forget about damaged material that costs time and money! Accommodates 24" by 24" boxed gaskets and most sizes of round gasket containers.

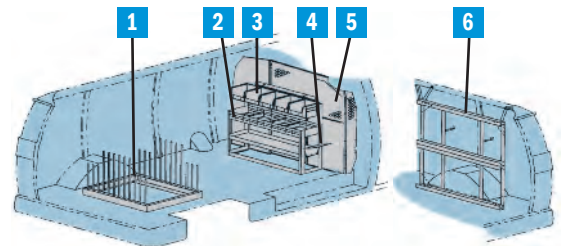

4145G AUTO GLASS INTERIOR PACKAGE GM Full-Size Long Wheelbase Vans

Item	Model	Description	Qty.
1	45047	S-111524B Burco Auto Glass Rack	1
2	AGSS24	Auto Glass Storage Station	1
3	28	Plastic Bins	5
4	AGSCH2	Suction Cup Holder	1
5	X1FSV	X1 Partition	1
6	AGTW4	Auto Glass Trim Weld Storage	1
7	WKX1FSVGM	Partition Wing Kit	1

PAINTING SERVICES UPFITS

MAKE YOUR NEXT VAN A WORK READY VAN!

Arrive at your next jobsite in style with a work van that has the equipment you need and a colorful graphic telling everyone the work that you do. A liner kit protects van walls from dings and paint splashes and a partition keeps all those paint cans safely in the cargo area. Add a roof or interior ladder rack to keep your ladders off the floor. Wrap it up with a custom graphic from Commercial Curb Appeal and you are ready to paint the town!



Poly Protecto-Van Liner Kit with Partition
page 40



Ladder Keeper Interior Ladder Rack
page 28



A professional looking work van tells customers that the work you do will be professional too.



61-1 Grip Lock ladder rack with LR6200WSF LoadsRite ladder rack add-on kit.
pages 24-25

Paint the town with a colorful, eye catching rolling billboard advertising you!



Graphic designed with:



More info on pages 4-5.

CATERING UPFITS



SHOULDN'T YOU LOOK AS GOOD AS THE FOOD YOU ARE DELIVERING?

Presentation is everything! Let your delivery van make a great impression with a custom graphic from Commercial Curb Appeal. On the inside be work ready with a liner package to keep your van looking neat, or a shelving package to keep your dishes organized.

4316G Shelf Kit with Partition



Poly Protecto-Van Liner Kit with Partition



AD series

Truly adjustable shelving allows you to move the shelves

to the height you need. Removable dividers pop in and out without the use of tools. A drawer unit can be located on any shelf and organizes small tools.

Graphic designed with:



More info on pages 4-5.

FLORAL DELIVERY UPFITS

BUILD BRAND AWARENESS WITH EACH DELIVERY!

Upfit your floral delivery van with a Durafloor and cargo partition. The Durafloor provides a durable, flat surface to keep vases, planters and displays upright for flawless delivery. The new customers that find you when you are making deliveries in your van with a graphic wrap from Commercial Curb Appeal will leave you smelling like a rose.



Durafloor Cargo Mats This floor system superior to plywood or rubber matting. It is a non-slip material that is odorless, non-toxic and easy to use.
page 20

Graphic designed with:



More info on pages 4-5.

EXPRESS ACCESS & SAVANA PRO

EXPRESS ACCESS & SAVANA PRO BIN UPFITS PROVIDE EASY ACCESS AND FLEXIBLE STORAGE.

Side panels allow access to parts and tools. Packages provide shelving, bins, and locking storage, plus trade specific items such as tank racks, vice mount, or wire reel holders.

2940G GENERAL SERVICE PACKAGE

Item	Model	Description	Qty.
1	24	Plastic Bin 15" X 8" X 7"	10
2	DK552A	Door Kit	1
3	AP6	KD Shelf Unit	1
4	919	Three Drawer Combo	1
5	MB121	Strside Frnt Sill Plate 44"	1
6	MB122	Strside Rear Sill Plate 52"	1
7	MB123	Crbside Sill Plate 42"	1
8	AP1	KD Shelf Unit	1
9	AP2	KD Shelf Unit	1
10	S1M2HC2FSV	Partition	1
11	WKC2FSVGM	Partition Wing Kit	1

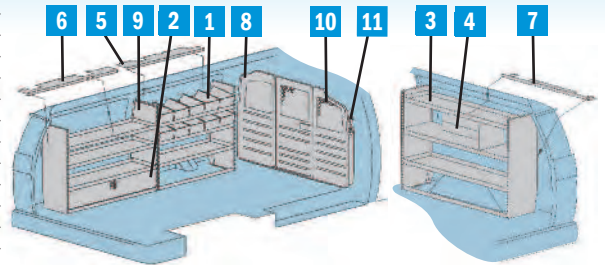

2942G HVAC INTERIOR PACKAGE

Item	Model	Description	Qty.
1	VM42	Floor Rail 42"	1
2	DV14	14" Divider	4
3	24	Plastic Bin 15" X 8" X 7"	12
4	DK544	Door Kit	1
5	VMA 36	Vise Mount Assembly	1
6	TA1	Hook Bar	2
7	TH50	50-lb. Tank Holder	1
8	SA-10	Single Wide Deep Stow-All	1
9	WTR230150	Three Tank Rack	1
10	919	Three Drawer Combo	1
11	MB121	Strside Frnt Sill Plate 44"	1
12	MB122	Strside Rear Sill Plate 52"	1
13	MB123	Crbside Sill Plate 42"	1
14	AP1	KD Shelf Unit	1
15	AP3	KD Shelf Unit	1
16	AP 5	KD Shelf Unit	1
17	S1M2HC2FSV	Partition	1
18	WKC2FSVGM	Partition Wing Kit	1

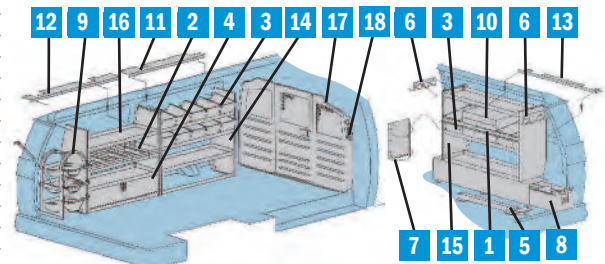

2941G ELECTRIC & GAS REPAIR PACKAGE

Item	Model	Description	Qty.
1	VM42	Floor Rail 42"	1
2	DV14	14" Divider	5
3	24	Plastic Bin 15" X 8" X 7"	12
4	TA1	Hook Bar	2
5	SA-10	Single Wide Deep Stow-All	1
6	WRH5	5-Bar Wire Reel Holder	1
7	919	Three Drawer Combo	1
8	MB121	Strside Frnt Sill Plate 44"	1
9	MB122	Strside Rear Sill Plate 52"	1
10	MB123	Crbside Sill Plate 42"	1
11	AP1	KD Shelf Unit	1
12	AP3	KD Shelf Unit	1
13	AP4	KD Shelf Unit	1
14	S1M2HC2FSV	Partition	1
15	WKC2FSVGM	Partition Wing Kit	1

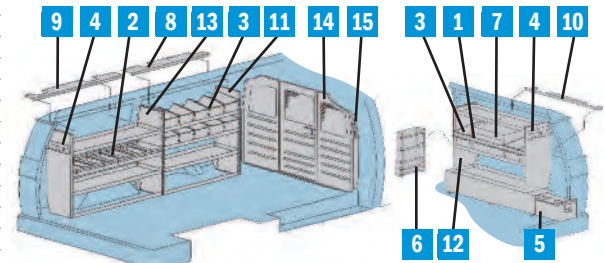

EXPRESS & SAVANA LEFT HAND DOOR



INCREASE ACCESS WITHOUT DECREASING STORAGE.

Left hand door packages allow quick access to your inventory and tools from both sides of the van, with no loss of cargo area storage. Plastic bins allow increased storage within an arms reach of either side door. Lockable storage and trade specific accessories are just a few of the package features.



For the Way You Work!

2945G GENERAL SERVICE PACKAGE

GM Full-Size
Left Hand Door
Long Wheelbase Vans

Item	Model	Description	Qty.
1	S1M2C2FSV	Partition	1
2	LHD1	KD Unit 12" X 36" X 52"	1
3	LHD2	KD Shelf Rack 14" X 46" X 42"	1
4	4442	Welded Shelf Rack	1
5	28	Plastic Bin 10" X 8" X 7"	6
6	919	Drawer Combo	1
7	TA1	Hook Bar	1
8	DK544	Door Kit	1
9	WKC2FSVGM	Partition Wing Kit	1

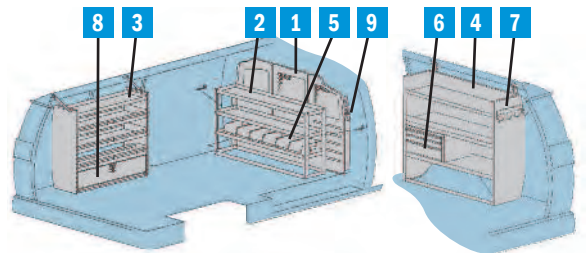

4320G COMMERCIAL BIN PACKAGE

GM Full-Size
Left Hand Door
Long Wheelbase Vans

Item	Model	Description	Qty.
1	S1M2C2FSV	Partition	1
2	LHD1	KD Unit 12" x 36" x 52"	1
3	28	Plastic Bin 10" x 8" x 7"	6
4	AD44FP	ADseries 44" shelf unit	2
5	RKFSVLHD	Rail Kit for ADseries	1
6	DV14C8	Divider 8 pack	1
7	919	Three Drawer Combo	1
8	TA1	Hook Bar	1
9	DK4208	8" Door Kit	1
10	WKC2FSVGM	Partition Wing Kit	1

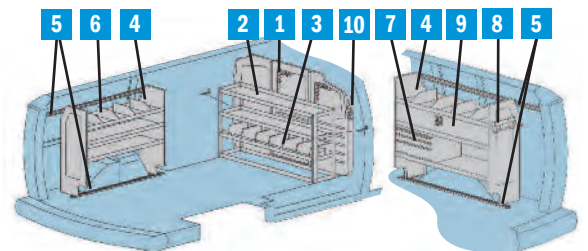

How to order:

Layout guide is on page 3. Order packages or components from charts. Include make, model, year and wheel-base of van. Optional Floor Mat ordering information is on page 20.

LINER PACKAGES



GM POLY PROTECTO-VAN LINER

Protect your GM van from the inside with a Protecto-Van Liner Kit.

- Designed to minimize the damage to the walls of your van.
- Liner panels are molded to conform to the shape of the van walls and run from floor to ceiling.
- The kit includes full length E-track and a hinged-door partition.
- Available for long and extended long wheelbase GM full size vans.

3056G - fits GM long wheelbase vans

3006G - fits GM left hand door vans

3057G - fits GM ext. long wheelbase vans



MAKE YOUR VAN WORK READY!



pages 22-24

Choose from the Grip-Lock or LoadsRite ladder racks to get your ladders out of the van and on the roof for secure transportation.



page 28

Keep the cargo floor open for transporting large items. A Ladder Keeper will keep a step ladder secure on the ceiling and out of the way!

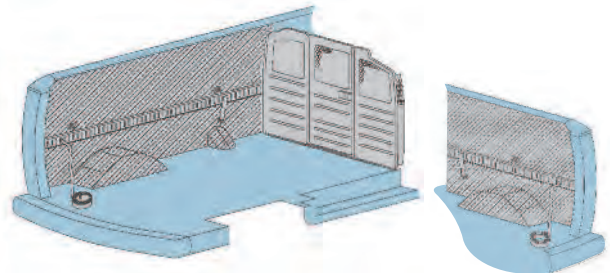

Vehicle fit: Poly Protecto-Van Liner fit full-size GM vans with long and extended long wheelbases. For use with 60/40 and sliding side doors.

Optional Floor Mat ordering information is on page 20.

INDEX

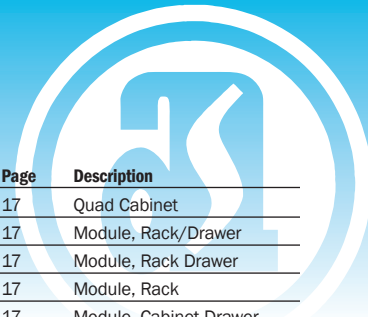

Model	Page	Description
ACT3	21	Aerosol Can Tray
ACT4	21	Aerosol Can Tray
AD32FP	9	32" ADseries
AD44FP	9	44" ADseries
AD50FP	9	50"ADseries
AFD181236	19	Aluminum Floor Drawer
AFD241224	19	Aluminum Floor Drawer
AFD241236	19	Aluminum Floor Drawer
AGR5H6L	35	Glass Rack
AGSCH2	35	Suction Cup Holder
AGSS24	35	Storage Station
AGTW4	35	Trim Weld Storage
AS12	27	Auxiliary Step
BH4	18	Binder Holder
BR36212	20	Bin System
BR76012	20	Bin System
BRK14EPS	9	End Panel Bracket
BS6VP	27	Light Mount
CB2	7,18	Two Book File
CB3	18	Three Book File
CB4	18	Utility Storage Box
CB5	18	Literature Holder
CB7	18	Literature Holder
CC17	27	Center Crossbar
CH1	18	DDF Cupholder
CL1446D	14	Cabinet Locker
CL1446R	14	Cabinet Locker
CRH2	21	Cable Reel Holder
CS9	21	9" Cargo Strap
CS15	21	15" Cargo Strap
CS21	21	21" Cargo Strap
CS31	21	31" Cargo Strap
DC6	15	Drawer Component
DC12	15	Drawer Component
DDF7	18	Driver Data File
DDF12	18	Driver Data File
DK3008	9	8" Door Kit
DK3010	9	10" Door Kit
DK4208	9	8" Door Kit
DK4210	9	10" Door Kit
DK4808	9	8" Door Kit
DK4810	9	10" Door Kit
DK530	10	30" Door Kit
DK530A	10	30" Door Kit
DK532	10,13	32" Door Kit
DK532A	10	32" Door Kit
DK536	10	36" Door Kit
DK536A	10	36" Door Kit
DK542	10	42" Door Kit
DK544	10,13	Door Kit
DK546	10	42" Door Kit
DK546A	10	42" Door Kit
DK550	13	Door Kit
DK552	10	52" Door Kit
DK552A	10	52" Door Kit
DS06112V	15	Drawer System
DS36012H	15	Drawer System
DS46012	15	Drawer System
DST21	21	Door Storage Tray
DT21	21	Door Tray
DTL21	21	Door Tray Lid
DTWL21	21	Door Tray w/Lid

Model	Page	Description
DV12	11	Divider 12"
DV14	11	Divider 14"
DV19	19	Divider/Stow-All
DV14C1	9	Divider/Single
DV14C8	9	Divider/8 Pack
DVJ9	19	Divider/Stow-All
DVJ19	19	Divider/Stow-All
DV9	19	Divider/Stow-All
DV44U	13	Divider/8 pack
DV44U1	13	Divider/upper
DV44U4	13	Divider/4 pack
DV44L1	13	Divider/lower
DV44L4	13	Divider/4 pack
EP1246	11	End Panel
EP1436	11	End Panel
EP1446	11	End Panel
FA6	11	Floor Angle 5"
FA12	11	Floor Angle 12"
FA14	11	Floor Angle 14"
FA18	11	Floor Angle 18"
FR12	11	Floor Rail 11-3/4"
FR18	11	Floor Rail 17-3/4"
FR24	11	Floor Rail 23-3/4"
FR30	11	Floor Rail 29-3/4"
FR32	11	Floor Rail 31-3/4"
FR36	11	Floor Rail 35-3/4"
FR42	11	Floor Rail 41-3/4"
FR52	11	Floor Rail 51-3/4"
HD1BAR	26	HD Crossbar
HD2BAR	26	HD Utility Rack
HD-32FP	10	32" Shelf Unit
HD-42FP	10	42" Shelf Unit
HD-52FP	10	52" Shelf Unit
JD42FP	10	42" Shelf Unit
JD52FP	10	52" Shelf Unit
JD48FP	10	48" Shelf Unit
JD60FP	10	60" Shelf Unit
KDRH1426	21	End Panel Reel Holder
KDRH1432	21	End Panel Reel Holder
KDRH1444	21	End Panel Reel Holder
KDRH1450	21	End Panel Reel Holder
KDRH2	21	Reel Holder
KMB18	34	18" Key Machine Base
KMB36	34	36" Key Machine Base
LK8	28	Ladder Keeper
LKB1	18	Aluminum Lock Box
LKX	28	Ladder Keeper Ext
LR6100WCF	23	LoadsRite/Single-curbiside
LR6100WSF	23	LoadsRite/Single-streetside
LR6200WCF	23	LoadsRite Add-on Kit - CS
LR6200WSF	23	LoadsRite Add-on Kit - SS
LR6300WF	23	Double LoadsRite
LR6400WCF	23	Combo LoadsRite - CS
LR6400WSF	23	Combo LoadsRite - SS
LRSLK612	23	Step Ladder Kit
LS3VP	27	Ladder Stop
MB111	21	Mounting Bracket
MB112	21	Mounting Bracket
MB113	21	Mounting Bracket
MB114	21	Mounting Bracket
MB115	21	Mounting Bracket
MB116	21	Mounting Bracket

Model	Page	Description
MD501	17	Quad Cabinet
MD502	17	Module, Rack/Drawer
MD503	17	Module, Rack Drawer
MD504	17	Module, Rack
MD505	17	Module, Cabinet Drawer
MD506	16	Module, Drawer Cabinet
MD507	16	Module, Drawer Rack
MD508	16	Module, Workbench
MD509	16	Module, Workbench
MD510	17	Module, KD Storage
MD511	17	Module, Drawer Cabinet
MD512	17	Module, Rack
MD513	17	Module, Cabinet
MD517	17	Module, KD Storage
MD520	10	KD Shelf Unit/KD 18"
MD521	10	KD Shelf Unit 24"
MD521B	10	KD Shelf Unit 24"
MD522	10	KD Shelf Unit 30"
MD522B	10	KD Shelf Unit 30"
MD523	10	KD Shelf Unit 36"
MD523B	10	KD Shelf Unit 36"
MD524	10	KD Shelf Unit 42"
MD524B	10	KD Shelf Unit 42"
MD525	17	Module, Workbench
MD526	17	KD Storage Unit 36"
MD527	17	Module, Shelf Cabinet
MD530	16	Module, Drawer Shelf
MD531	16	Module, Cabinet
MD532	16	Module, Cabinet Shelf
MD533	16	Module, Drawer Shelf
MD534	16	Module, Drawer Rack
MD535	16	Module, Drawer Cabinet
MD608	16	Module, Workbench
PA5-1	7	Plexiglas Panel
PA5-2	7	Plexiglas Panel
PA5-3GMS	7	Plexiglas Kit
PA5-6GMS	7	Plexiglas Kit
PA7	7	Reflector Flare Kit
PA8	7	Fire Extinguisher
PA9	7	First Aid Tray
PA10	7	Practice Holder
PA11	7	Cab File Box
PDK1	7	Partition Door Kit
PS1FSV	6	Partition, Polysteel
RKA1	9	Rail Kit Adapter
RKA3	9	Rail Kit Adapter
RKA4	9	Rail Kit Adapter
RKABRK1	9	Rail Kit Adapter
RKABRK2	9	Rail Kit Adapter
RKAWTR	9	Rail Kit Adapter
RKA919	9	Rail Kit Adapter
RKFSVLHD	9	Rail System
RKFSVLWB	9	Rail System
RKFSVXLWB	9	Rail System
RR5	27	Cargo Rack Roller
RS4	27	Ratchet Strap
S1M1C1FSV	6	Partition FSV
S1M2C1FSV	6	Partition FSV
S1M2HC1FSV	6	Partition FSV
S1M2C2FSV	6	Partition FSV
S1M2HC2FSV	6	Partition FSV
S2M2C2FSV	6	Partition FSV

INDEX

Model	Page	Description
S2M2HC2FSV	6	Partition FSV
SA-10	19	Stow-All/Single/Deep
SA-20	19	Stow-All/Double/Deep
SA-40	19	Stow-All/Quad/Deep
SAJ-10	19	Stow-All/Sgl/Shallow
SAJ-20	19	Stow-All/DbI/Shallow
SAJ-30	19	Stow-All/Triple/Shallow
SAJ-40	19	Stow-All/Quad/Shallow
SBIN060614	20	6" Plastic Bin
SBIN120614	20	12" Plastic Bin
SBINDIV	20	Plastic Bin Divider
SF11212	11	Shelf 12" x 12"
SF11224	11	Shelf 12" x 24"
SF11230	11	Shelf 12" x 30"
SF11236	11	Shelf 12" x 36"
SF11242	11	Shelf 12" x 42"
SF11836	11	Shelf 18" x 36"
SF11842	11	Shelf 18" x 42"
SF11218DC	13	DC Unit Shelf
SF11224DC	13	DC Unit Shelf
SF11236DC	13	DC Unit Shelf
SF21224	11	Top Tray 12" x 24"
SF21230	11	Top Tray 12" x 30"
SF21232	11	Top Tray 12" x 32"
SF21236	11	Top Tray 12" x 36"
SF21242	11	Top Tray 12" x 42"
SF21252	11	Top Tray 12" x 52"
SF21432	11	Top Tray 14" x 32"
SF21442	11	Top Tray 14" x 42"
SF21452	11	Top Tray 14" x 52"
SF41236	11	HD Shelf 12" x 36"
SF41432	11	HD Shelf 14" x 32"
SF41442	11	HD Shelf 14" x 42"
SF41452	11	HD Shelf 14" x 52"
SH12	27	Step Handle
SPT-4	15	SP Tote/Combo
SPT-4P	15	SP Tote/Poly
SPT-4S	15	SP Tote/Steel
SPT-S	15	SPT Steel Tray
SPT-P	15	SPT Poly Tote
SRAILAD26	20	Bin Retention Rail 26"
SRAILAD32	20	Bin Retention Rail 32"
SRAILAD44	20	Bin Retention Rail 44"
SRAILAD50	20	Bin Retention Rail 50"
SSK-BS	26	Side Stop Kit
SSK-BA	26	Side Stop Kit
SSK-HD	26	Side Stop Kit
SSK-WA	26	Side Stop Kit
SSK-WS	26	Side Stop Kit
STP12G	21	Paint, Gray
STP12W	21	Paint, White
STP12B	21	Paint, Black
TA1	7,21	Hook Bar
TA2	21	Hard Hat Holder
TA3	21	Saw Holder
TA18	14	Propane Tank Cab.
TA19	14	CO2 Tank Cabinet
TA20	14	Mapp Gas Cabinet
TH30	7	Freon Tank Holder
TH50	7	Freon Tank Holder
TK10	19	Traction Kit
TK20	19	Traction Kit

Model	Page	Description
TK30	19	Traction Kit
TK40	19	Traction Kit
UH10	21	Utility Hook
UH25	21	Utility Hook
UH50	21	Utility Hook
VM12	11	Vertical Member 12"
VM14	11	Vertical Member 14"
VM18	11	Vertical Member 18"
VM24	11	Vertical Member 24"
VM30	11	Vertical Member 30"
VM36	11	Vertical Member 36"
VM42	11	Vertical Member 42"
VM46	11	Vertical Member 46"
VM48	11	Vertical Member 48"
VMA36	21	Vise Mount Assm.
VP1	27	Perimeter Rack
VPE1	27	Perimeter Rack Ext
WKC1FSVGM	6	Wing Kit
WKC1FSVGM3	6	Wing Kit 3"
WKC2FSVGM	6	Wing Kit
WKC2FSVGM3	6	Wing Kit 3"
WKX1FSVGM	6	Wing Kit
WKX1FSVGM3	6	Wing Kit 3"
WRH5	21	Wire Reel Holder
WTR130250	20	Tank Rack
WTR230150	20	Tank Rack
WTR330	20	Tank Rack
WTR350	20	Tank Rack
WTR430	20	Tank Rack
WTRTRAY	20	Top Tray
X1FSV	6	Partition
1	14	Cabinet
10619	11	Top Tray 18" x 60"
1A	14	Shelf
1BAR-B	26	Crossbar/Black
1BAR-W	26	Crossbar/White
1BRS-B	26	Crossbar/Black
1BRS-W	26	Crossbar/White
2	15	Drawer Unit
2BAR-B	26	Utility Rack/Black
2BAR-W	26	Utility Rack/White
2BRS-B	26	Utility Rack/Black
2BRS-W	26	Utility Rack/White
3	10	KD Shelf Rack
3A	11	Top Tray 12" x 18"
4A	11,21	Parts Tray
4B	11,21	Parts Tray
8	15	Drawer Unit
9	15	Drawer Unit
12	14	Cabinet
12A	11,14	End Panel
14	21	Step Stool
17A	18	Catalog File
18	12	Utility Shelf
19	15	Drawer Unit
25	15	Divider/#2
26	15	Divider/#8
27	15	Divider/#19
30-32	10	32" Storage Shelf
30-42	10	42" Storage Shelf
30-52	10	52" Storage Shelf
33	10	KD Shelf Rack

Model	Page	Description
33W	10	Shelf Rack
33WB	10	Shelf Rack w/bins
40	14	Wheelhouse Bin
43	18	Catalog File
53-9	21	Roof Vent
60-21	21	Window Screen
60-22	21	Window Screen
60-23	21	Window Screen
60-24	21	Window Screen
60-25	21	Window Screen
60-26	21	Window Screen
61-1	25	Grip-Lock Rack
63-1	25	Grip-Lock Rack
64-1	25	Grip-Lock Rack
65-1	27	Utility Rack
66-1	27	Utility Rack
67-1	27	Utility Rack
68-3	25	Step Ladder Kit
69-4	25	Rack Extension Kit
70-1	27	Conduit Kit
70-2	27	Conduit Kit
71	27	Tie Down Kit
72	27	Cross Support
72-F	27	Cross Support
73	27	Ladder Pad Kit
75	27	Light Stand
76	25	Rail Cover Kit
80-1	25,27	Conduit Carrier
80-2	25,27	Conduit Carrier
88-2	20	Workmat
88-9	20	Workmat
89-GMVTO	20	Durafloor
89-GMXVTO	20	Durafloor
98	17	Wheelhouse Frame
99	17	Wheelhouse Frame
919	15	Drawer Unit
2251G	31	PHVAC Pkg
2252G	33	Elect. Pkg
2253G	34	Alarm Pkg
2255G	34	Locksmith Pkg
2256G	29	Gen. Contr. Pkg
2257G	29	Gen. Contr. Pkg
2258G	32	Cable Pkg
2261G	31	PHVAC Pkg
2262G	33	Elect. Pkg
2940G	38	Access/Pro Pkg
2941G	38	Access/Pro Pkg
2942G	38	Access/Pro Pkg
2945G	39	Left Hand Door Pkg
3006G	40	Protecto-Van Liner
3056G	40	Protecto-Van Liner
3057G	40	Protecto-Van Liner
3230G	32	Cable Pkg.
35325-G	9	32" Shelf ADseries
35327-G	9	44" Shelf ADseries
35328-G	9	50" Shelf ADseries
4135G	30	44 Series Pkg
4136G	30	44 Series Pkg
4138G	30	44 Series Pkg
4145G	30	Auto Glass Pkg
4317G	29	Gen Svc Pkg GM
4317GX	29	Gen Svc Pkg GM

INDEX



Model	Page	Description
4318G	31	PHVAC Pkg GM
4318GX	31	PHVAC Pkg GM
4319G	33	Electrical Pkg GM
4319GX	33	Electrical Pkg GM
4320G	39	Left Hand Door Pkg
4432	13	32" Welded Cabinet
4442	13	42" Welded Cabinet
4450	13	50" Welded Cabinet
45047	35	Burco Glass Rack

ADRIAN STEEL COMPANY

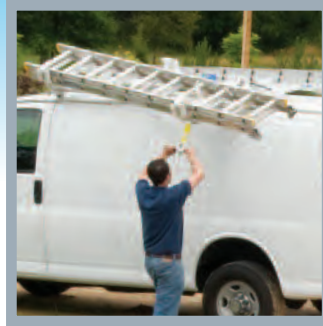

QUALITY

- Our products are durable and reliable. Warranty claims are less than 1% of sales.
- Our warranty covers our products for three years or 36,000 miles.

INNOVATIVE PRODUCTS WITH FEATURES THAT MATTER

- Drawers that stay closed while in transit.
- ADseries truly adjustable shelving platform.
- LoadsRite and Grip-Lock ladder racks that load and unload the safe and right way.
- Interior ladder storage.
- Plug and Play accessories.
- Anti-slam drawer latches, and much more!

COMMITMENT

- At Adrian Steel, we are committed to you beyond the upfit!
 - A dedicated Customer Care Team at corporate headquarters.
 - A network of highly qualified distributors to support you locally.
 - Our commitment to provide the best cargo management solutions in North America.



EXPERIENCE

- **Over One Million vans upfitted**, and counting! It's a fact that an organized vehicle increases work flow efficiencies and reduces inventory damages.
- Recognized as a National Truck Equipment Association MVP.



SERVICE

- Adrian Steel Products can be purchased throughout North America at authorized Adrian Steel distributors.
- Adrian Steel Customer Service Representatives are available M-F, 8am - 5pm EST at **1-800-677-2726**.
- E-mail us at info@adriansteel.com with questions, comments and feedback.
- Visit AdrianSteel.com for the most up-to-date product information, distributor locator, product catalogs, videos and more.

PROUDLY DISTRIBUTED BY:



906 James Street
Adrian, Michigan 49221-3996
517-265-6194 Fax: 517-265-5834
Toll Free 800-677-2726
adriansteel.com info@adriansteel.com